

HOPE

design Francisco Gomez Paz / Paolo Rizzatto

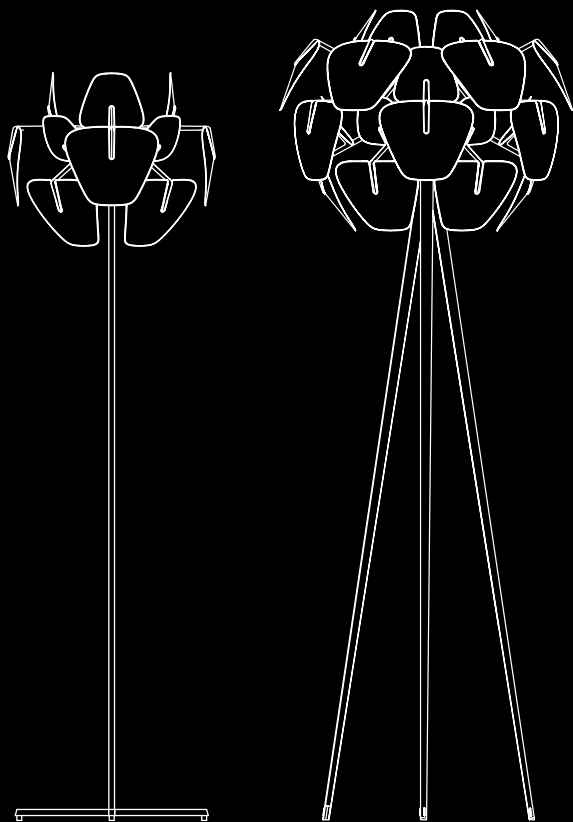

**LUCE
PLAN**

D66



D66/8td

D66/18td

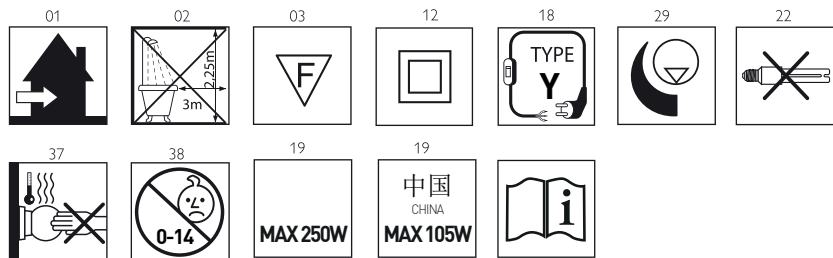

D66/8ti

D66/18ti

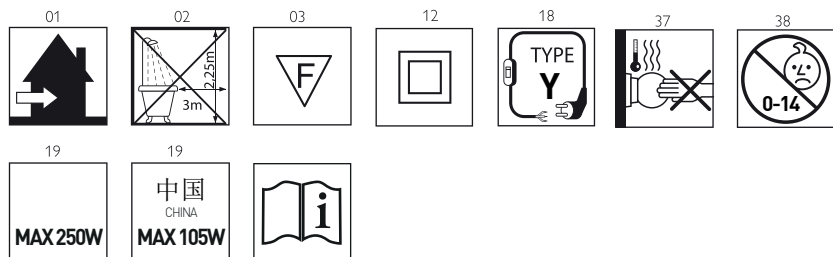

D66/8td
D66/8ti

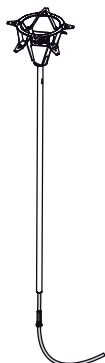
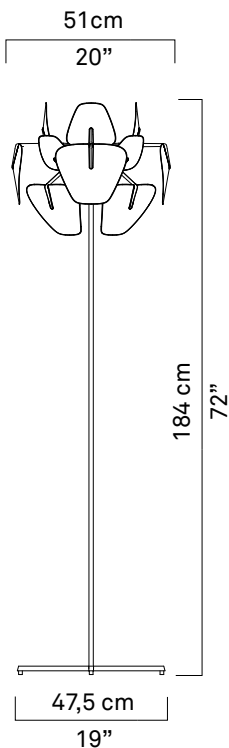

x1

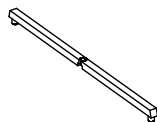

x2



x8



x8



x8

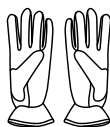

x1



x2

kg 4 kg

lb 8.8 lb

D66/8td D66/8ti

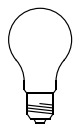

max 250W
E27

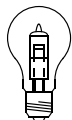

max 105W
HSGSA
E27
Energy saver

D66/8ti

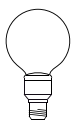

max 23W
FB
E27
fluorescent

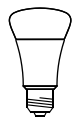

max 20W
SBLEDLAMP
E27

1 D66/8td
D66/8ti

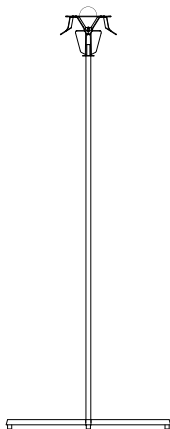

1.1

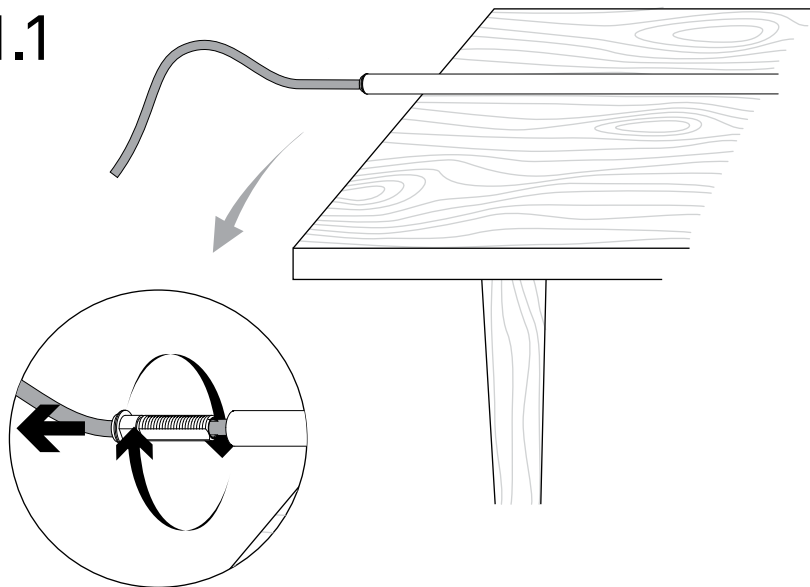

1.2

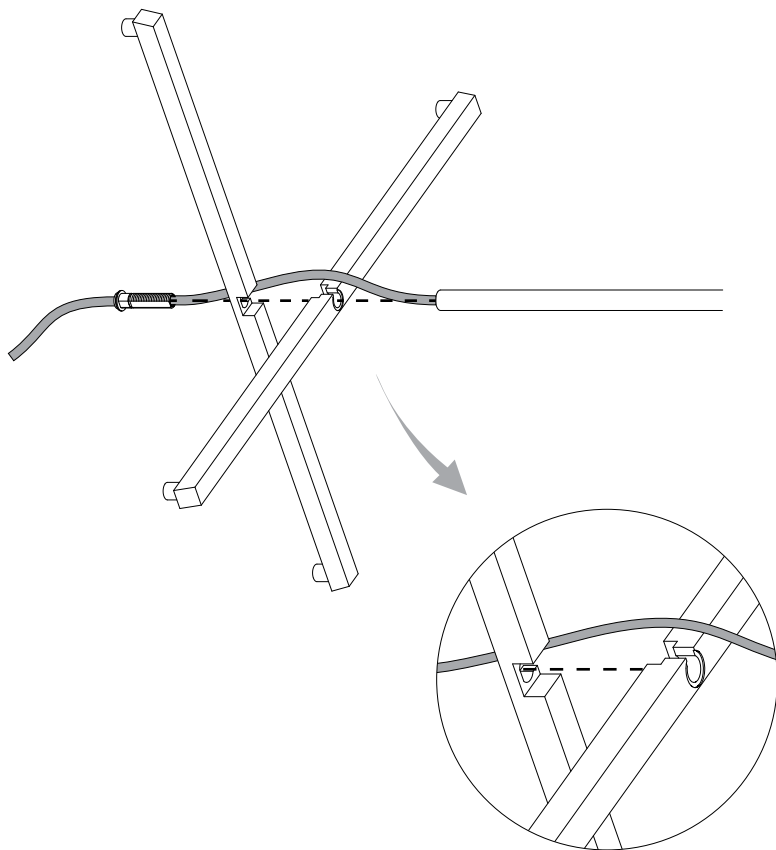

1.3

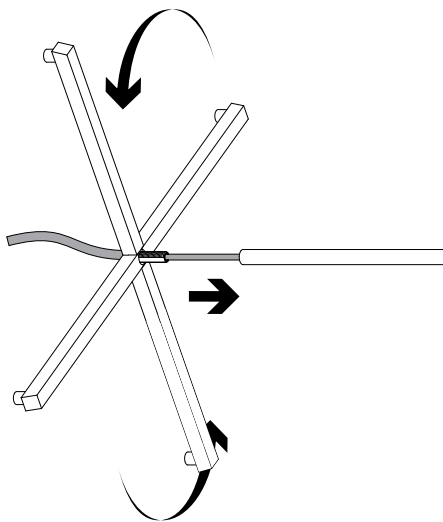

1.4

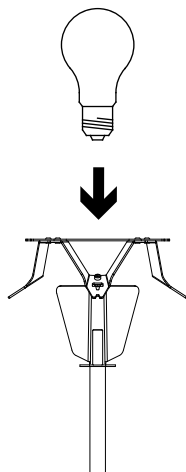

D66/18td D66/18ti

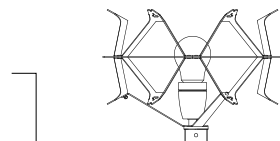
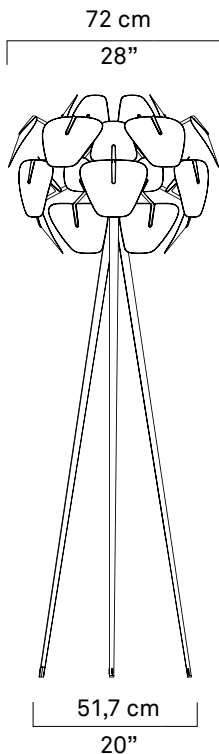

x1

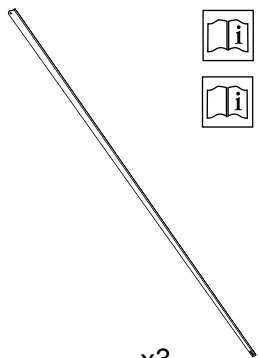

x3
(D66/18T.1)



x18



x18



x18



x1



x2

kg 5,3 kg

lb 11.7 lb

D66/18td D66/18ti

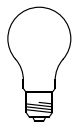

max 250W
E27

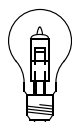

max 105W
HSGSA
E27
Energy saver

D66/18ti

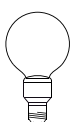

max 23W
FB
E27
fluorescent

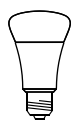

max 20W
SBLEDLAMP
E27

1

D66/18td + D66/18T.1
D66/18ti + D66/18T.1

1.1

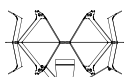
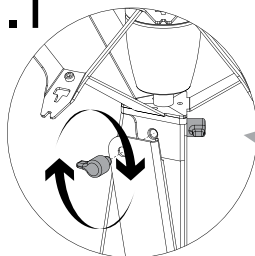

1.2



1.3

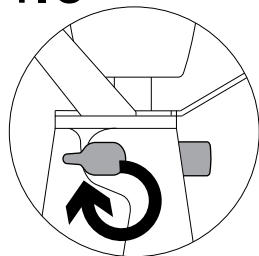

1.4

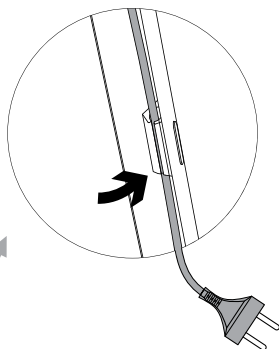

1.5

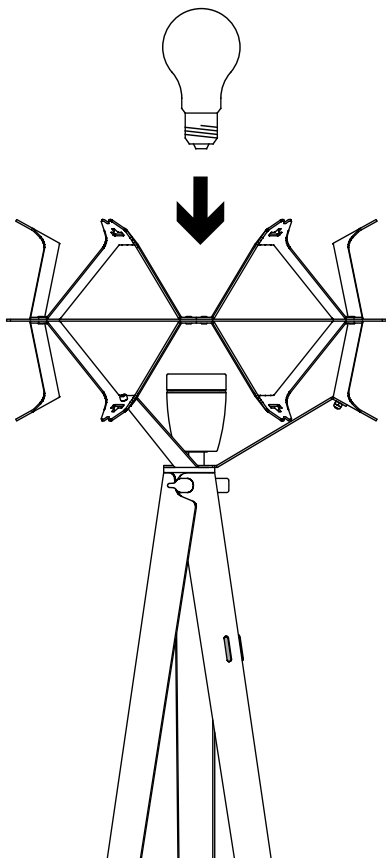

2

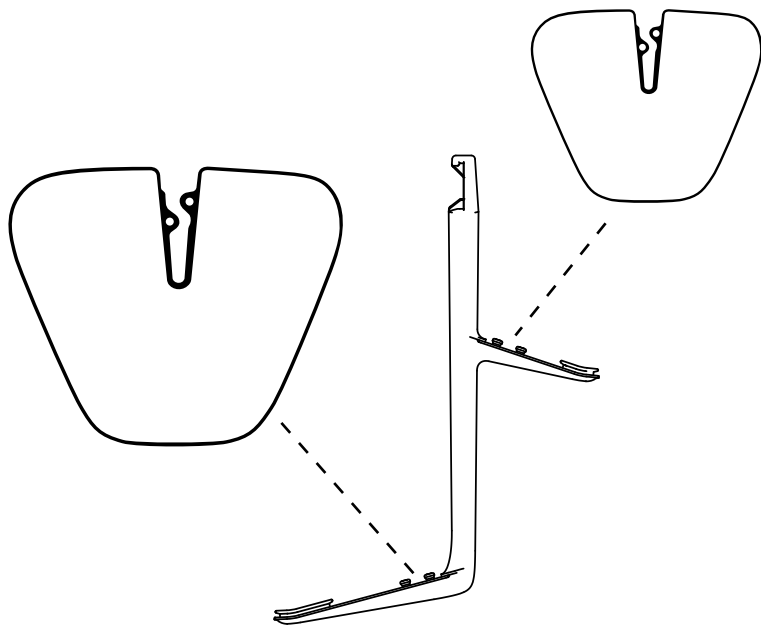

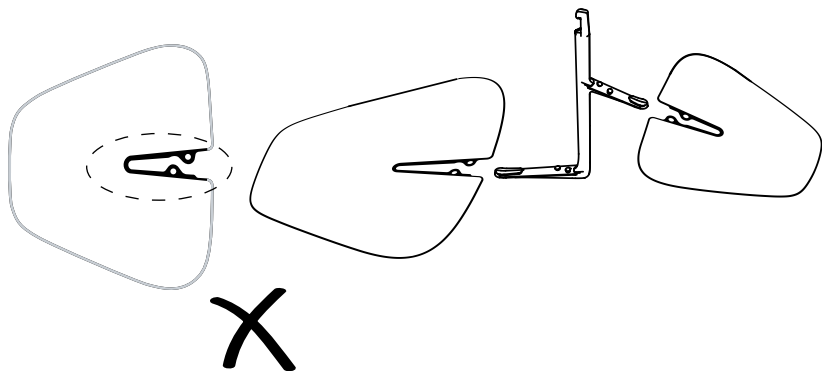
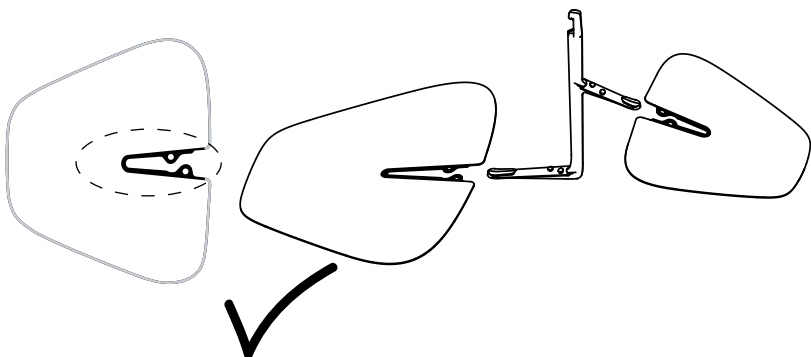

2.1

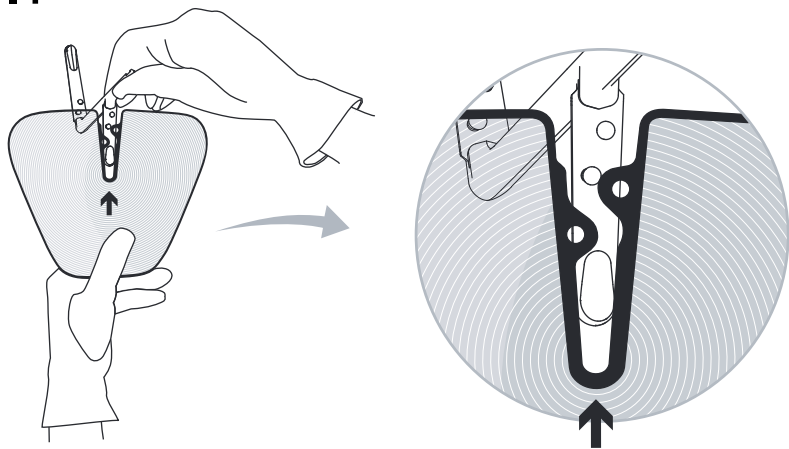

2.2

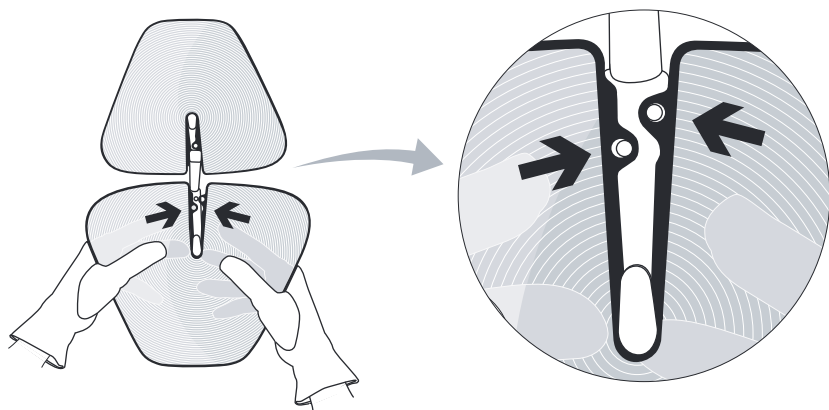

3

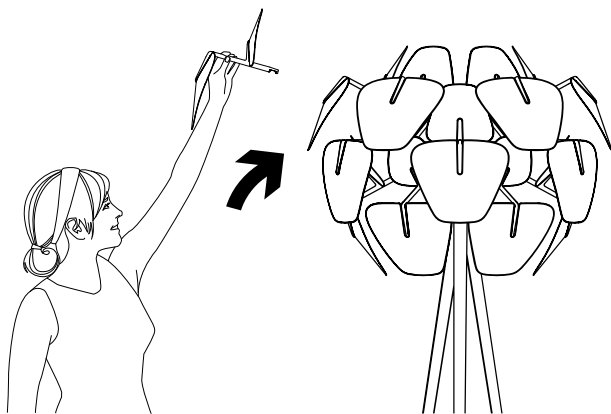
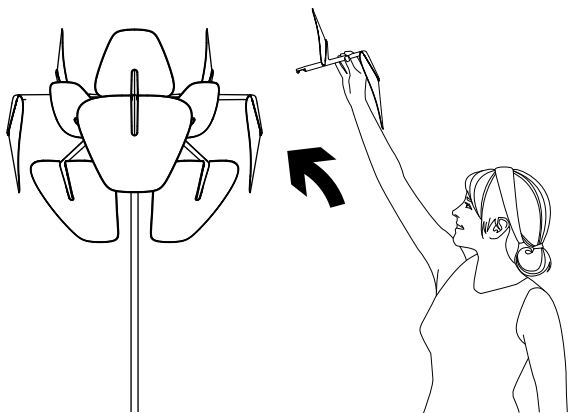

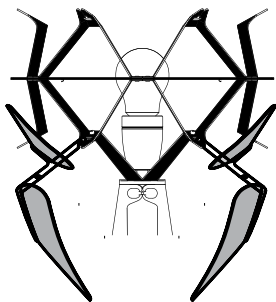

1.

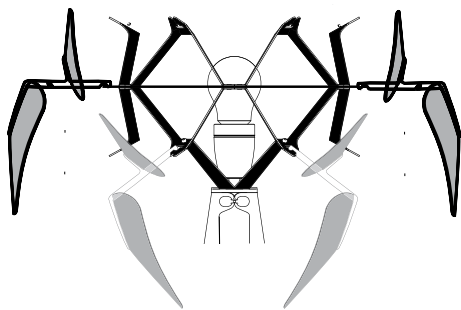

2.

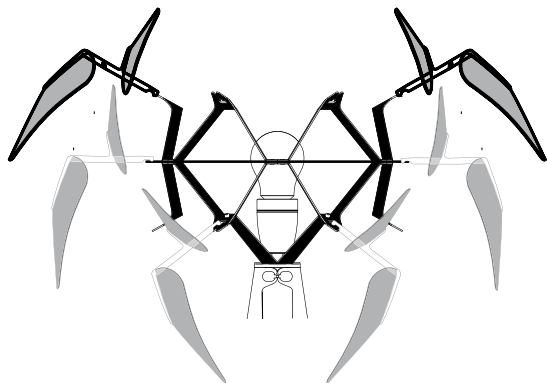

3.

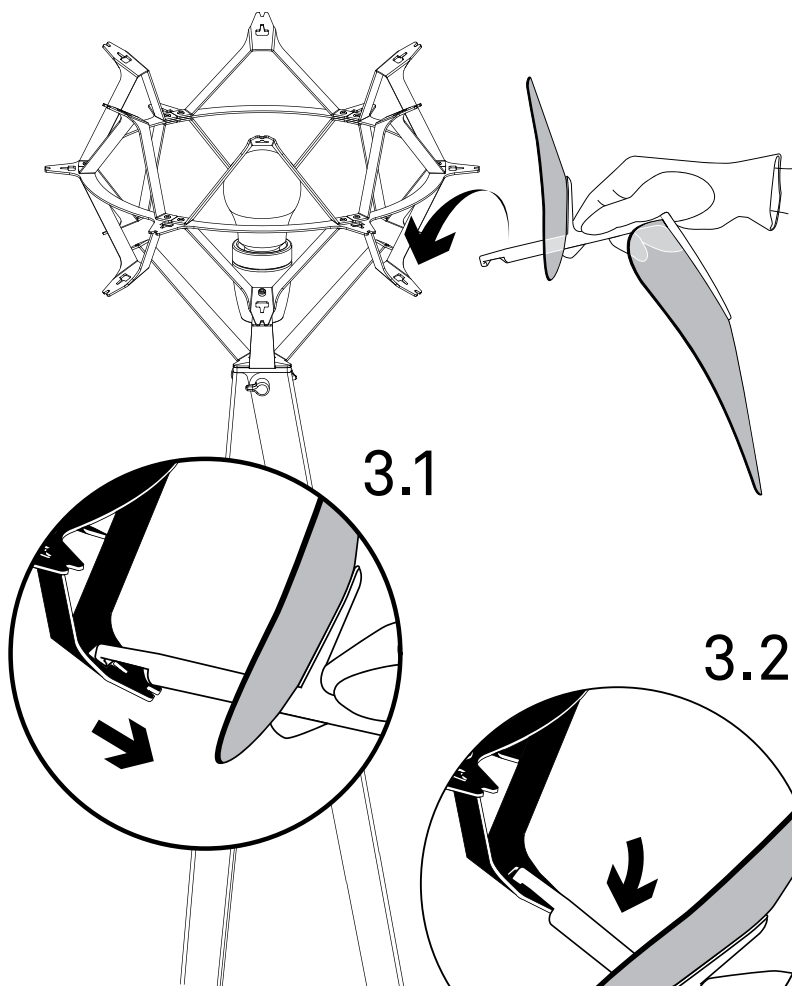

4

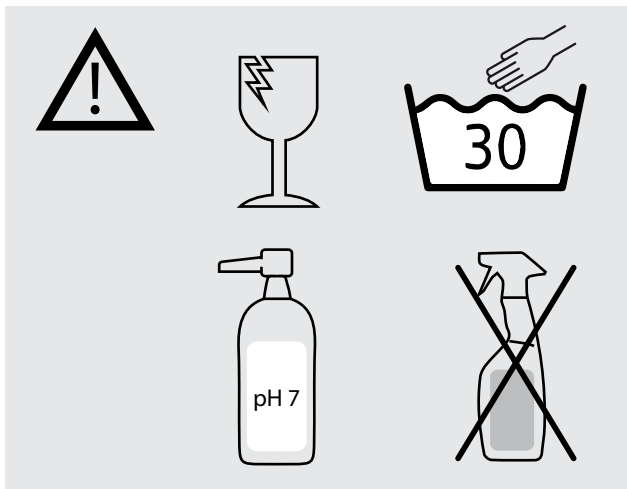
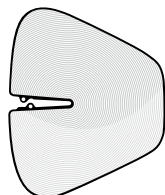
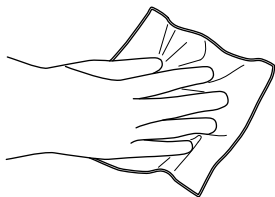

x1

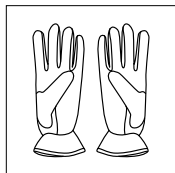

x2

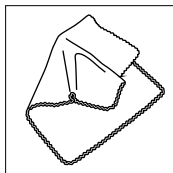

4.1

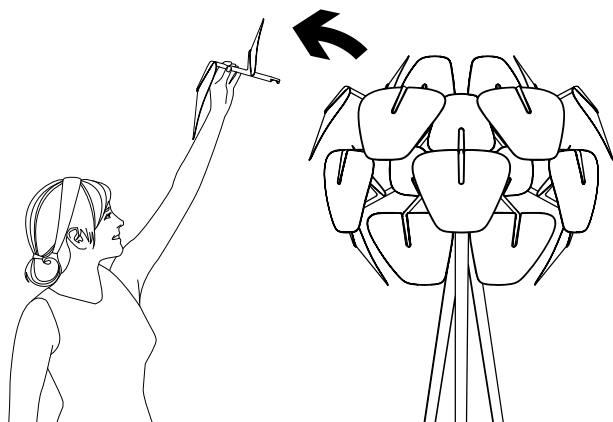
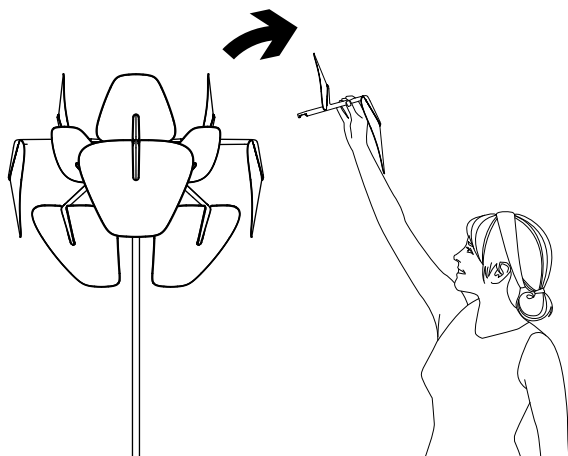

1.

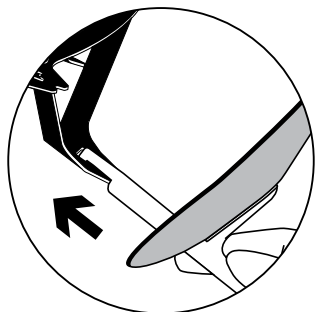

2.

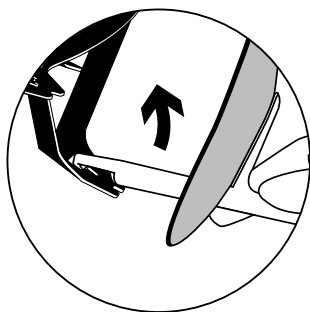

3.

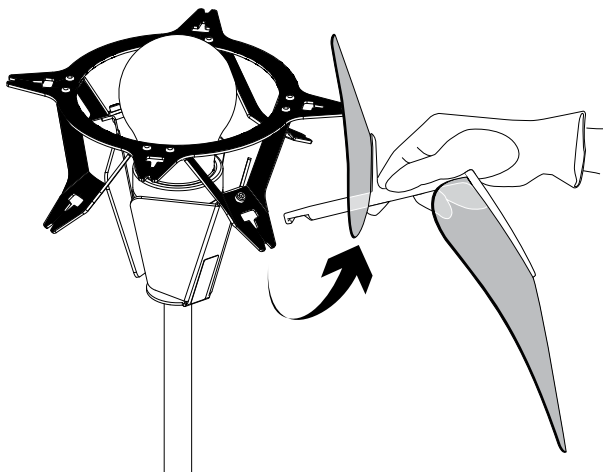

4.2

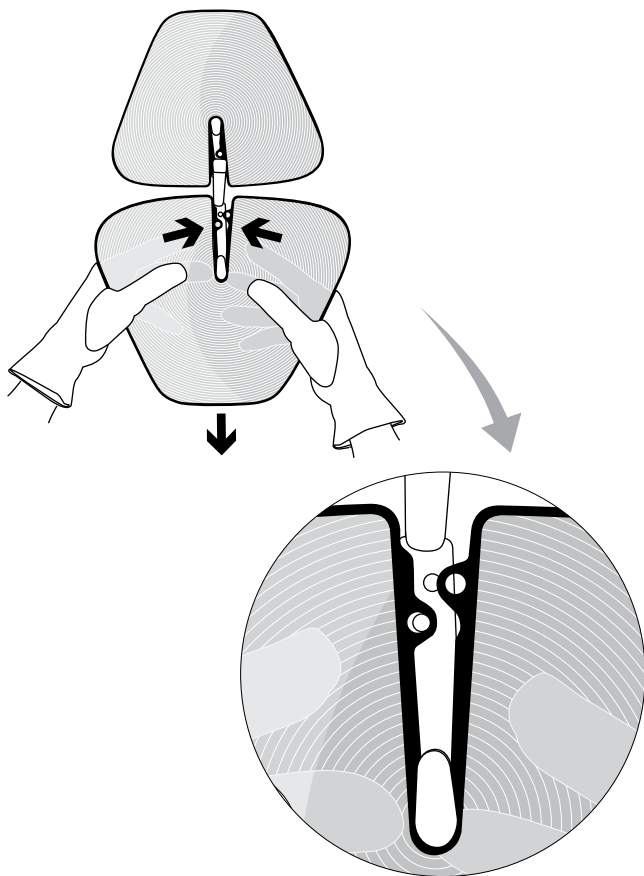

4.3

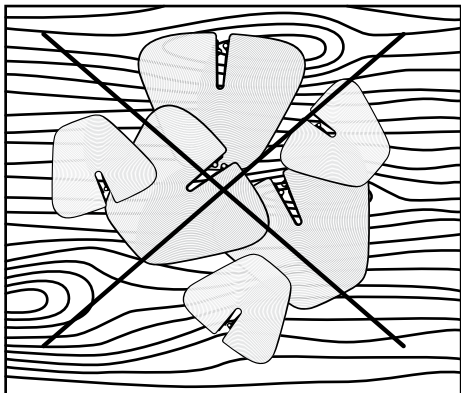

X

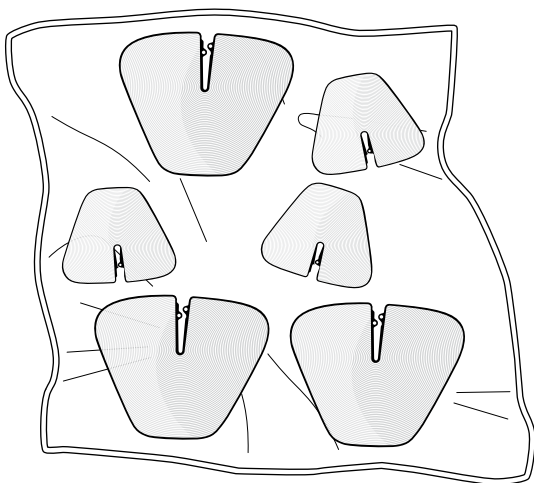

✓

4.4

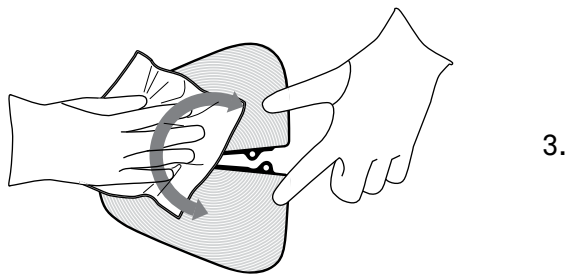
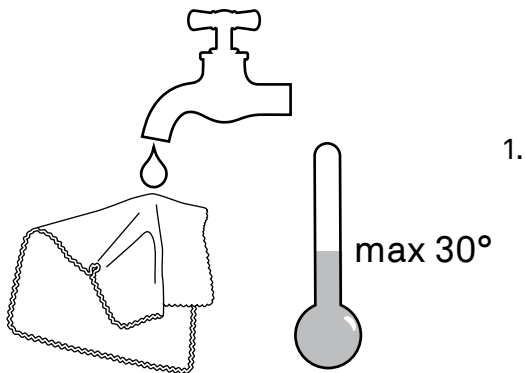

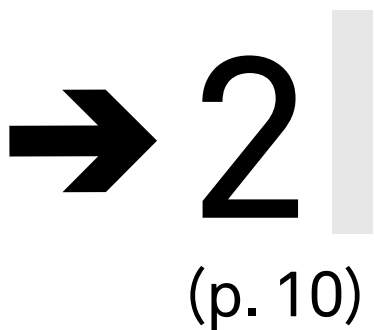



www.luceplan.com

D66010202