

METROPOLI

design Alberto Meda / Paolo Rizzato / Riccardo Sarfatti

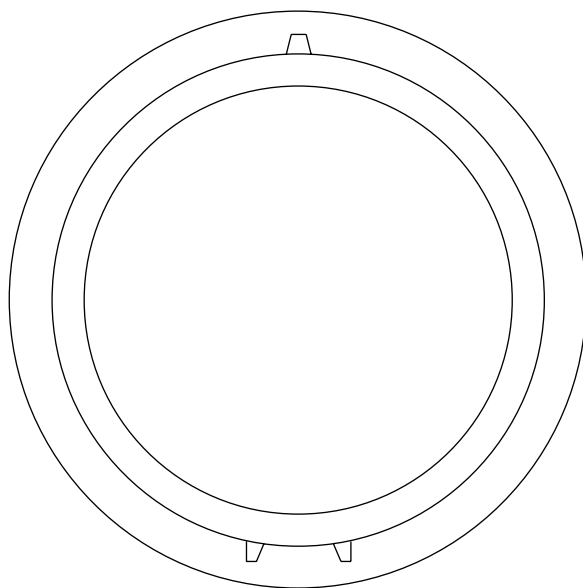

**LUCE
PLAN**

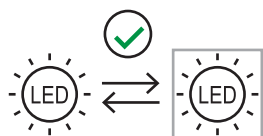

D20/17

ECODESIGN

EN SYMBOL LEGEND
 IT LEGENDA DEI SIMBOLI
 DE ERLAEUTERUNG DER SYMBOLE
 FR LEGENDE DES SYMBOLES
 ES LEYENDA DE LOS SIMBOLOS

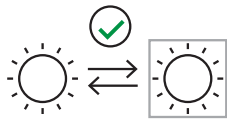

EN Replaceable light source by end-user
 IT Fonte luminosa sostituibile dal cliente finale
 DE Auswechselbare Lichtquelle durch den Endanwender
 FR Source lumineuse remplaçable par l'utilisateur final
 ES Fuente de luz reemplazable por el usuario final

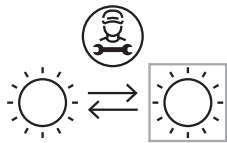

EN Replaceable light source by a professional
 IT Fonte luminosa sostituibile da un professionista
 DE Auswechselbare Lichtquelle durch einen Fachmann
 FR Source lumineuse remplaçable par un professionnel
 ES Fuente de luz reemplazable por un profesional

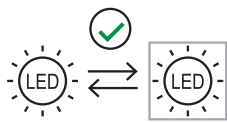

EN Replaceable (LED only) light source by end-user
 IT Fonte luminosa (solo LED) sostituibile dal cliente finale
 DE Auswechselbare (nur LED) Lichtquelle durch den Endanwender
 FR Source lumineuse remplaçable (LED uniquement) par l'utilisateur final
 ES Fuente de luz reemplazable (sólo LED) por el usuario final

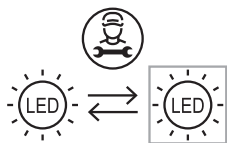

EN Replaceable (LED only) light source by a professional
 IT Fonte luminosa (solo LED) sostituibile da un professionista
 DE Auswechselbare (nur LED) Lichtquelle durch einen Fachmann
 FR Source lumineuse remplaçable (LED uniquement) par un professionnel
 ES Fuente de luz reemplazable (sólo LED) por un profesional



EN Non-replaceable light source
 IT Fonte luminosa non sostituibile
 DE Nicht austauschbare Lichtquelle
 FR Source lumineuse non remplaçable
 ES Fuente de luz no reemplazable

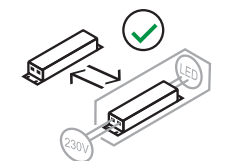

EN Replaceable control gear by a end-user
 IT Unità di alimentazione sostituibile dal cliente finale
 DE Austauschbares Vorschaltgerät durch einen Endanwender
 FR Pièce d'alimentation remplaçable par l'utilisateur final
 ES Unidad de alimentación reemplazable por el usuario final

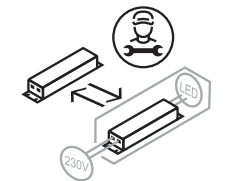

EN Replaceable control gear by a professional
 IT Unità di alimentazione sostituibile da un professionista
 DE Austauschbares Vorschaltgerät durch einen Fachmann
 FR Pièce d'alimentation remplaçable par un professionnel
 ES Unidad de alimentación reemplazable por un profesional

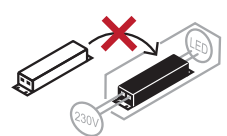

EN Non-replaceable control gear
 IT Unità di alimentazione non sostituibile
 DE Nicht austauschbares Vorschaltgerät
 FR Pièce d'alimentation non remplaçable
 ES Unidad de alimentación no reemplazable

EN USE ONLY ORIGINAL SPARE PARTS
 IT UTILIZZARE SOLO RICAMBI ORIGINALI
 DE VERWENDEN SIE NUR ORIGINAL-ERSATZTEILE
 FR UTILISER SEULEMENT DES PIÈCES DE RECHANGE D'ORIGINE
 ES UTILIZAR EXCLUSIVAMENTE REPUESTOS ORIGINALES

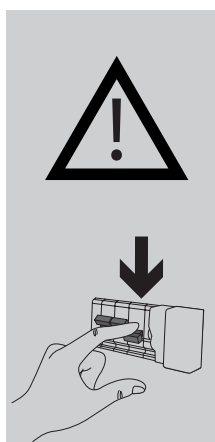
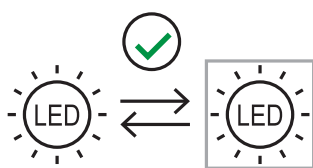

1



2



3

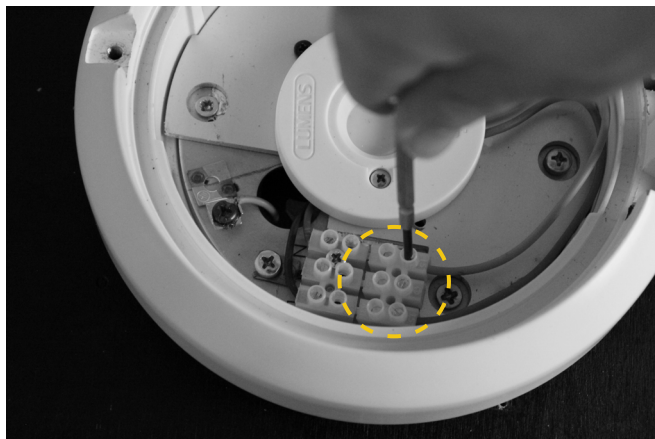

4



5

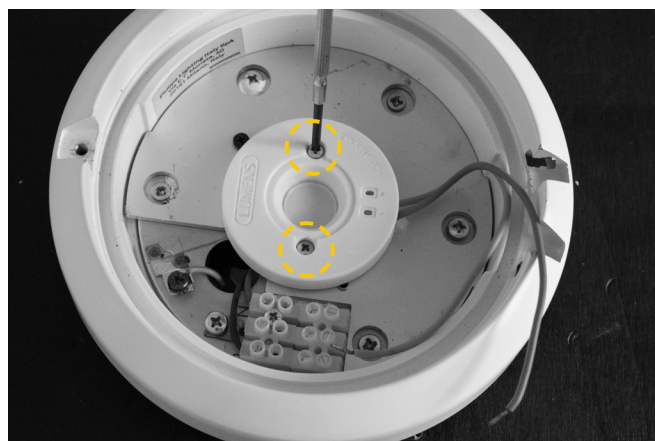

6

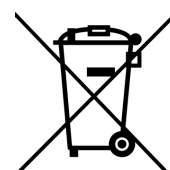



- EN** Replace the old component with the new one by reversing the sequence.
- IT** Sostituire il vecchio componente con il nuovo, invertendo la sequenza.
- DE** Ersetzen die alte Komponente mit einer Neue beim Umkehren der Reihenfolge.
- FR** Remplacer l'ancienne pièce par la nouvelle, en inversant la séquence.
- ES** Sustituir el componente antiguo por el nuevo, invirtiendo la secuencia.

METROPOLI

design Alberto Meda / Paolo Rizzato / Riccardo Sarfatti

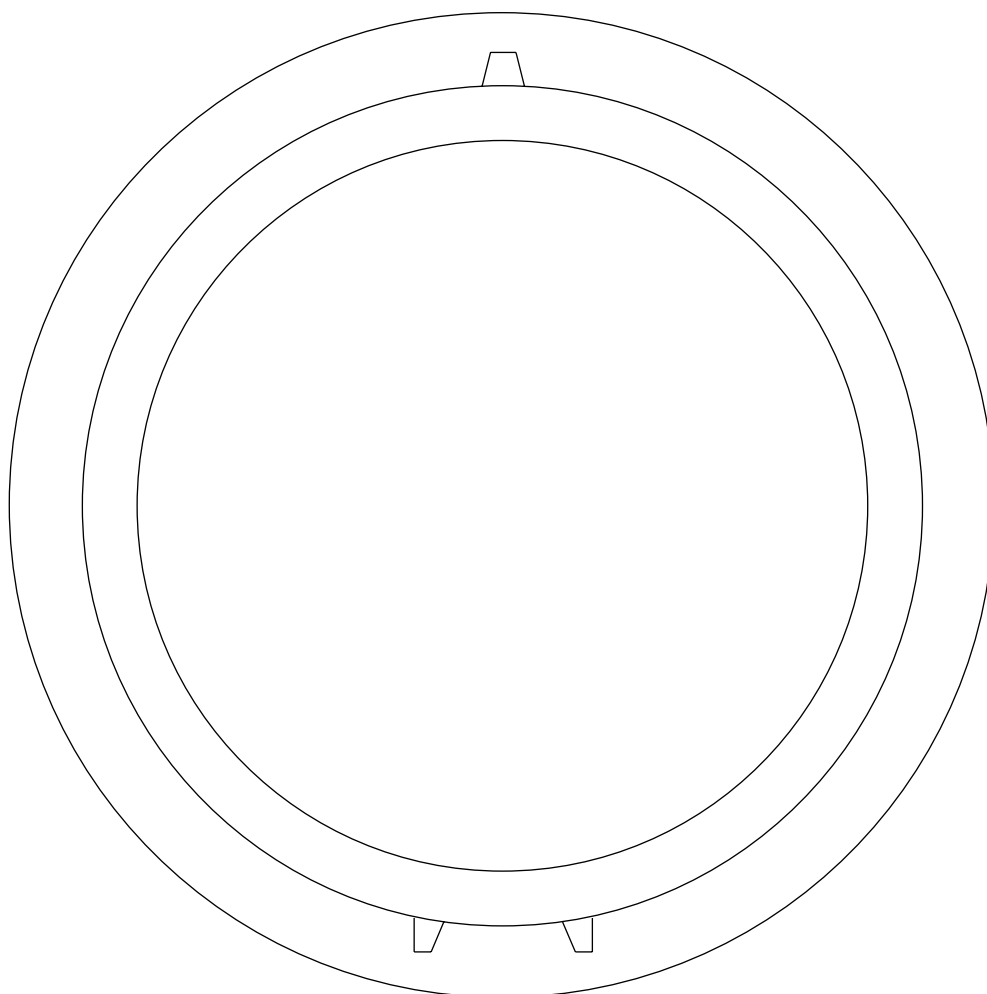

**LUCE
PLAN**

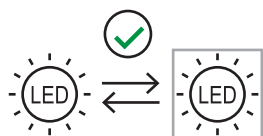

D20/27

ECODESIGN

EN SYMBOL LEGEND
 IT LEGENDA DEI SIMBOLI
 DE ERLAEUTERUNG DER SYMBOLE
 FR LEGENDE DES SYMBOLES
 ES LEYENDA DE LOS SIMBOLOS

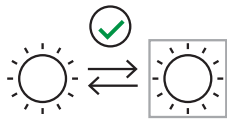

EN Replaceable light source by end-user
 IT Fonte luminosa sostituibile dal cliente finale
 DE Auswechselbare Lichtquelle durch den Endanwender
 FR Source lumineuse remplaçable par l'utilisateur final
 ES Fuente de luz reemplazable por el usuario final

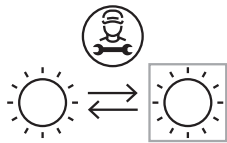

EN Replaceable light source by a professional
 IT Fonte luminosa sostituibile da un professionista
 DE Auswechselbare Lichtquelle durch einen Fachmann
 FR Source lumineuse remplaçable par un professionnel
 ES Fuente de luz reemplazable por un profesional

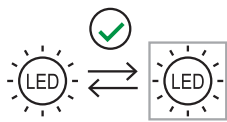

EN Replaceable (LED only) light source by end-user
 IT Fonte luminosa (solo LED) sostituibile dal cliente finale
 DE Auswechselbare (nur LED) Lichtquelle durch den Endanwender
 FR Source lumineuse remplaçable (LED uniquement) par l'utilisateur final
 ES Fuente de luz reemplazable (sólo LED) por el usuario final

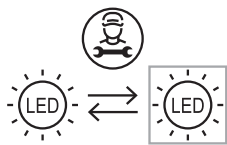

EN Replaceable (LED only) light source by a professional
 IT Fonte luminosa (solo LED) sostituibile da un professionista
 DE Auswechselbare (nur LED) Lichtquelle durch einen Fachmann
 FR Source lumineuse remplaçable (LED uniquement) par un professionnel
 ES Fuente de luz reemplazable (sólo LED) por un profesional



EN Non-replaceable light source
 IT Fonte luminosa non sostituibile
 DE Nicht austauschbare Lichtquelle
 FR Source lumineuse non remplaçable
 ES Fuente de luz no reemplazable

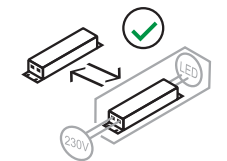

EN Replaceable control gear by a end-user
 IT Unità di alimentazione sostituibile dal cliente finale
 DE Austauschbares Vorschaltgerät durch einen Endanwender
 FR Pièce d'alimentation remplaçable par l'utilisateur final
 ES Unidad de alimentación reemplazable por el usuario final

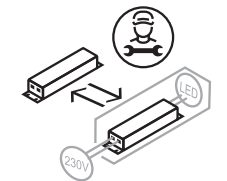

EN Replaceable control gear by a professional
 IT Unità di alimentazione sostituibile da un professionista
 DE Austauschbares Vorschaltgerät durch einen Fachmann
 FR Pièce d'alimentation remplaçable par un professionnel
 ES Unidad de alimentación reemplazable por un profesional

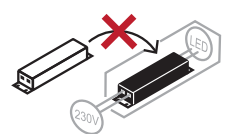

EN Non-replaceable control gear
 IT Unità di alimentazione non sostituibile
 DE Nicht austauschbares Vorschaltgerät
 FR Pièce d'alimentation non remplaçable
 ES Unidad de alimentación no reemplazable

EN USE ONLY ORIGINAL SPARE PARTS
 IT UTILIZZARE SOLO RICAMBI ORIGINALI
 DE VERWENDEN SIE NUR ORIGINAL-ERSATZTEILE
 FR UTILISER SEULEMENT DES PIÈCES DE RECHANGE D'ORIGINE
 ES UTILIZAR EXCLUSIVAMENTE REPUESTOS ORIGINALES

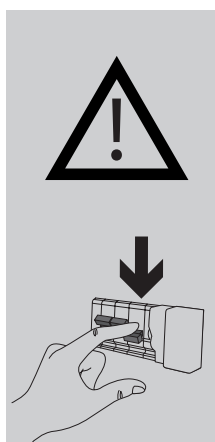
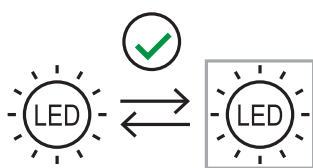

1

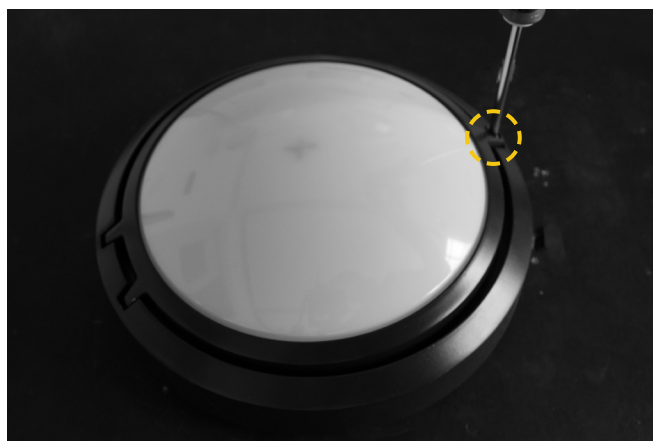

2

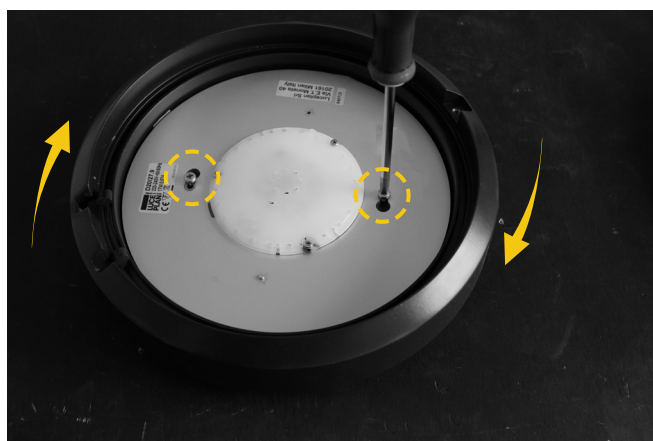

3

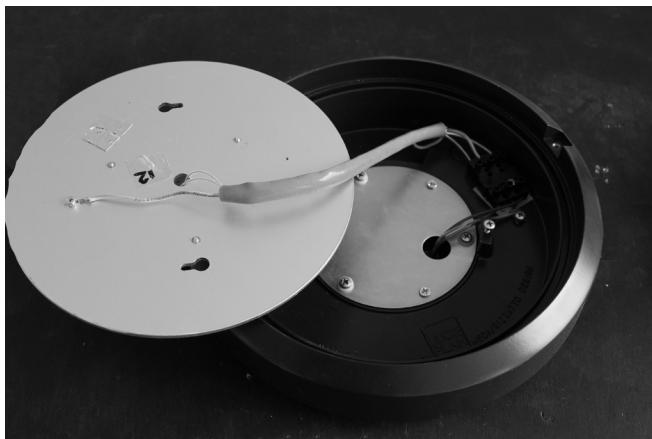

4

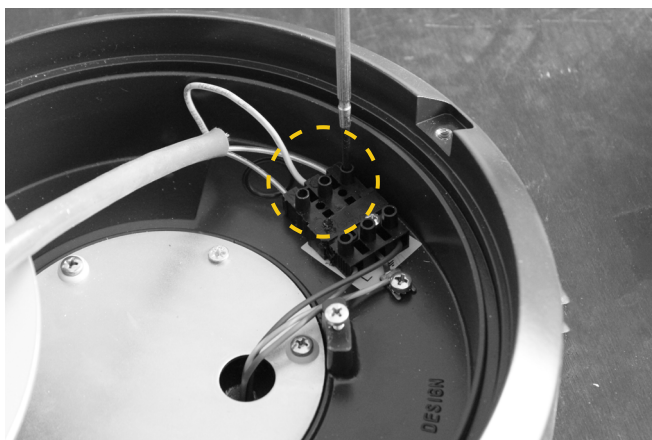

5

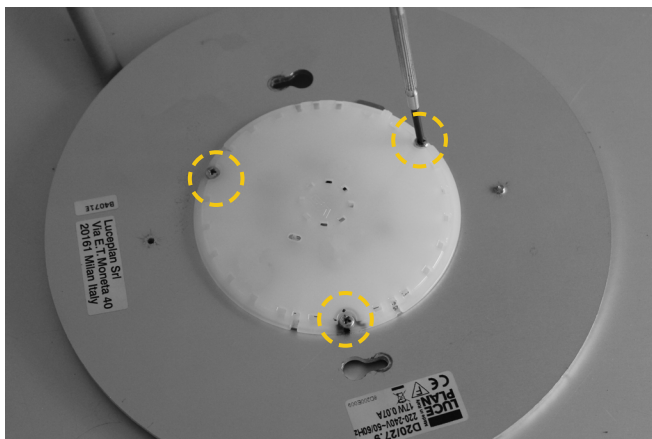

6

