

A04 FLIA

design Alessandro Zambelli



**LUCE
PLAN**

A04TP1B - A04TP1C



A04TP1B - A04TP1C

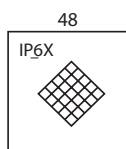
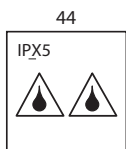
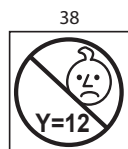
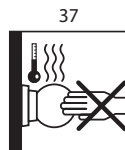
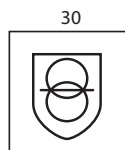
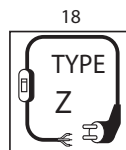
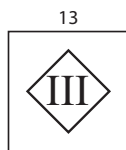
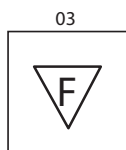
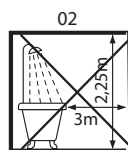

A04TP1B - A04TP1C



a



b

120cm (A04TP1B)
180 cm (A04TP1C)
47.2" (A04TP1B)
70.9" (A04TP1C)

10 cm
3.9"
13.5 cm
5"



14 cm
5.5"

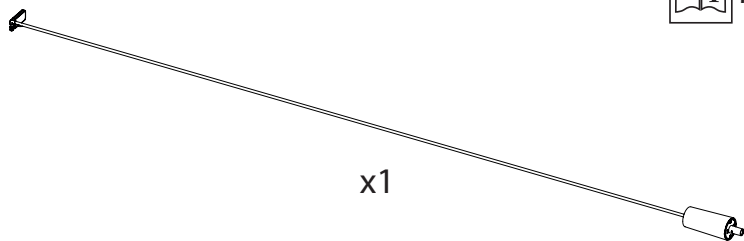

x1

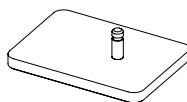

x1



x1



x1

kg 1 kg

lb 2,2 lb

1

1.1

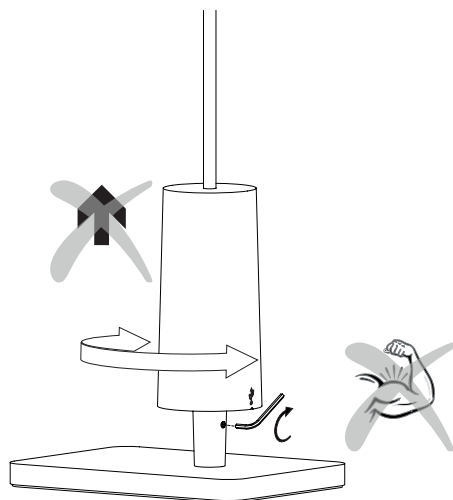
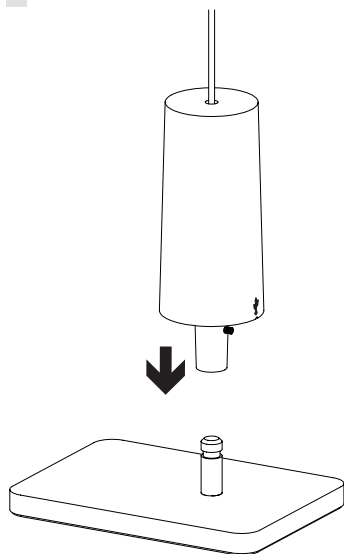

1.2

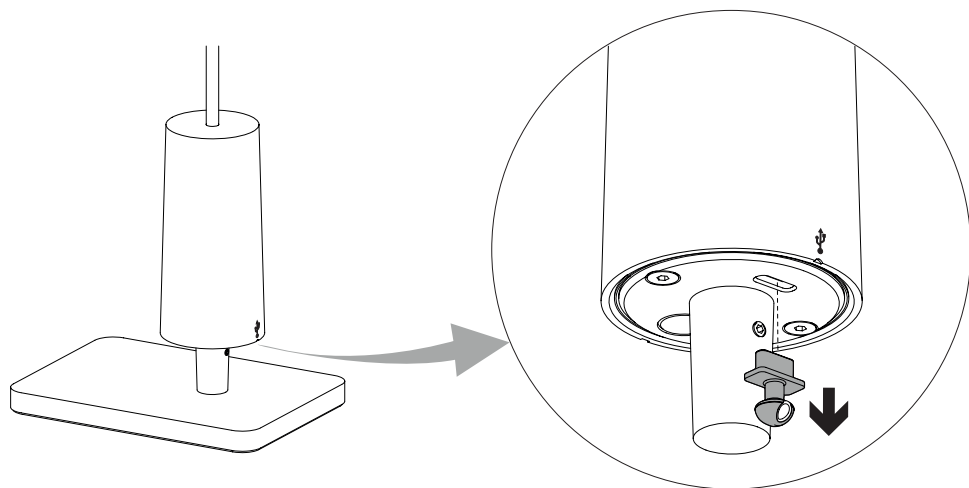
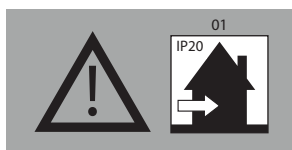

1.3

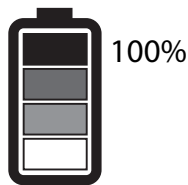
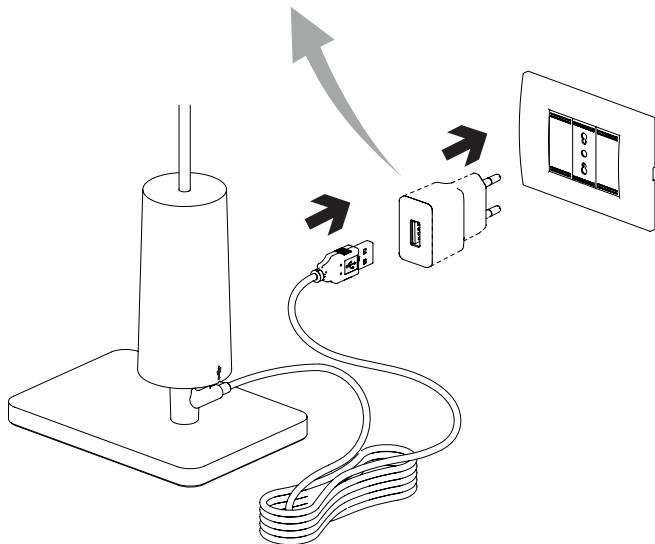
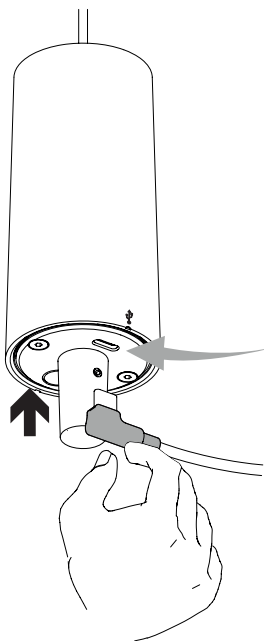

4 h

(4000mAh battery,
indoor charging only
between 0°C and +25°C)

	100%	4h 26min*
	70%	4h 53min
	40%	8h 26min

4000mAh battery discharge @20°C

Battery performance varies with temperature

* 1h 14min @100% → 3h 12min @70%

Max. discharge temperature -20°C +60°C

1.4

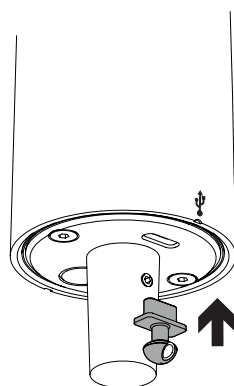
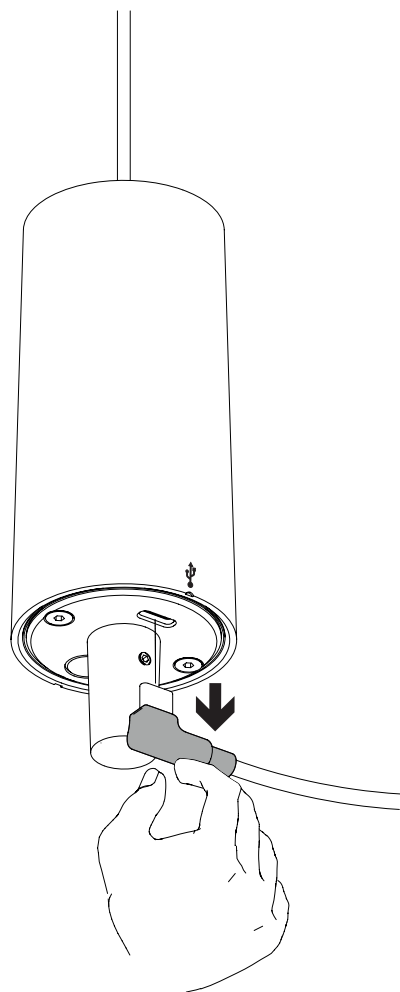

2

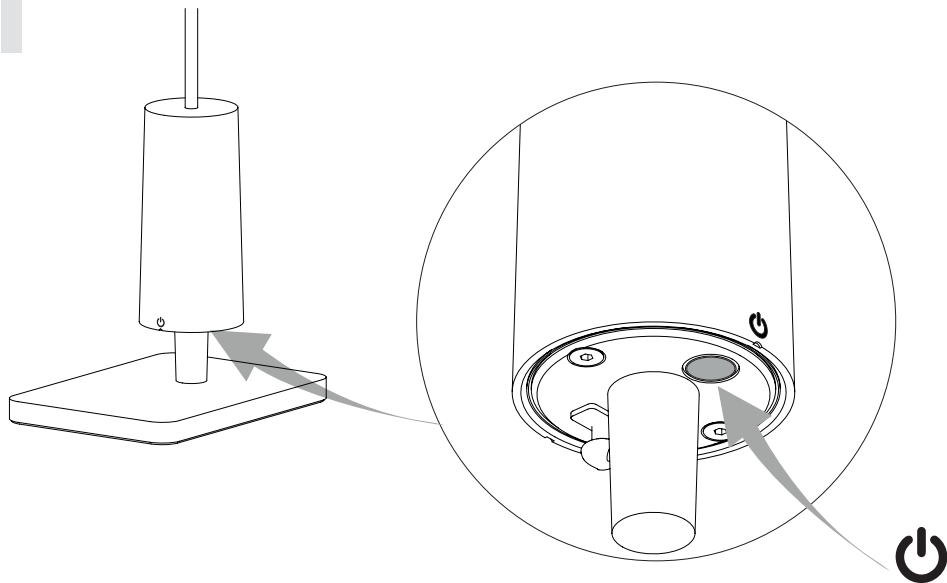

2.1 OPTIONAL DIMMER SETUP

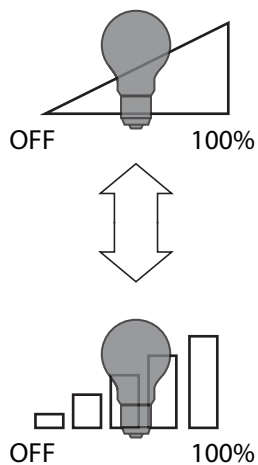
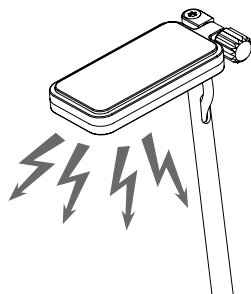

2.2

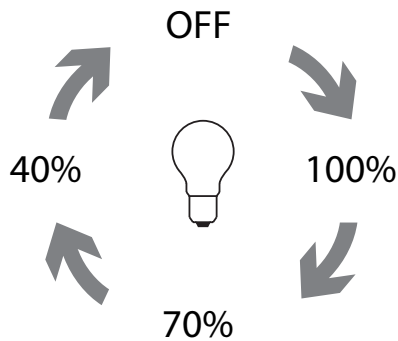
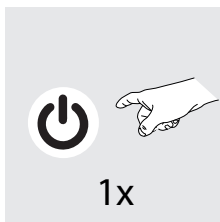
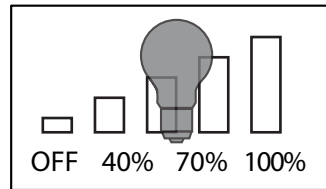
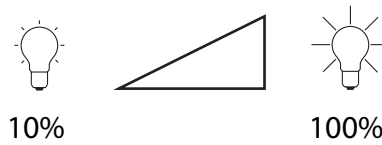
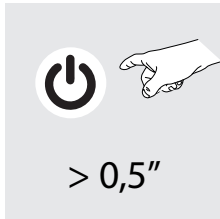
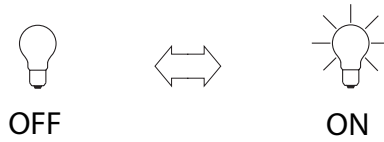
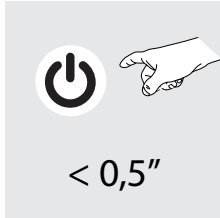
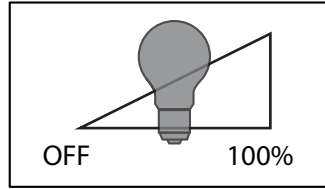

3

3.1

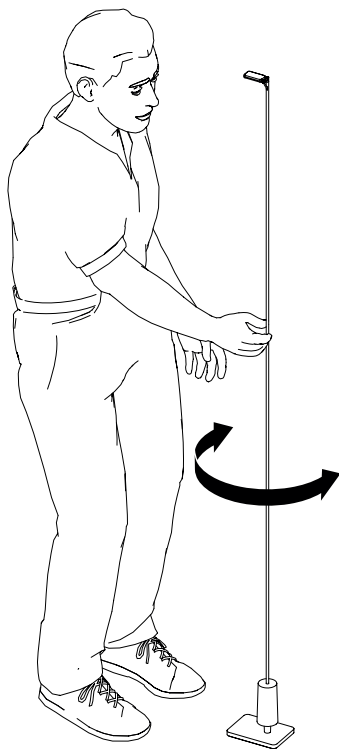

3.2

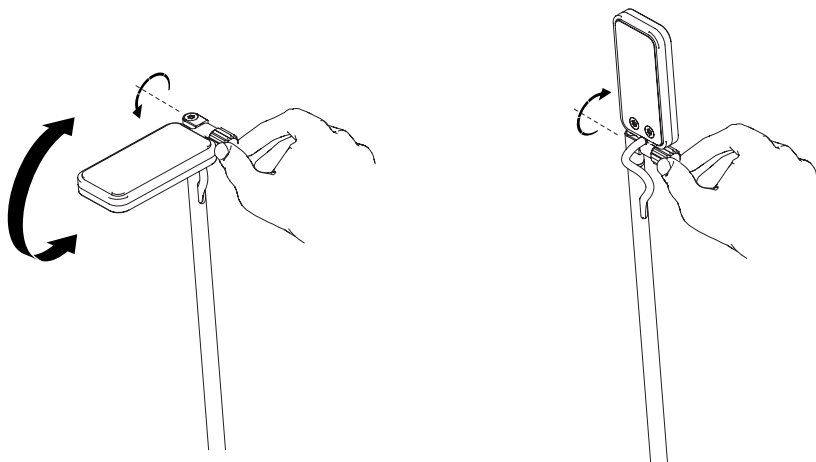



4

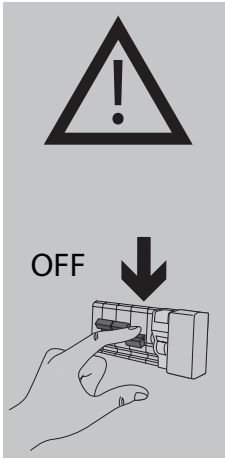

1.

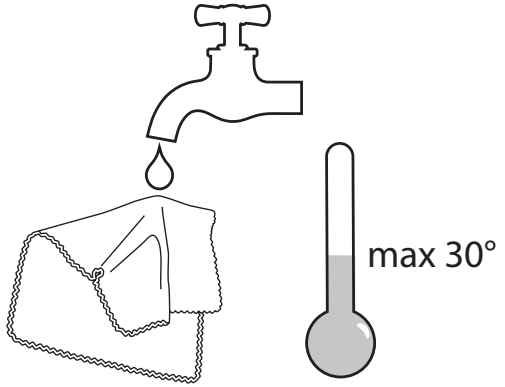

2.

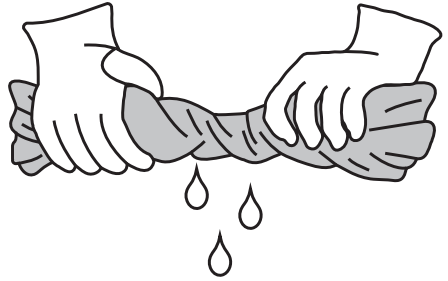

3.

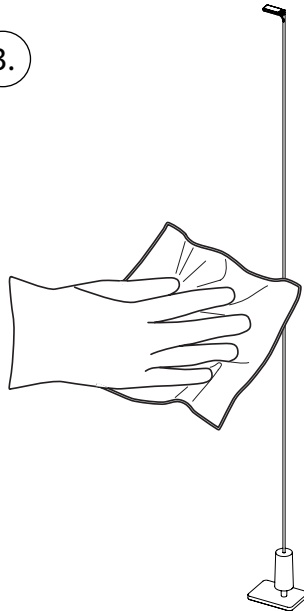



www.luceplan.com

A040IB001