

Luceplan

Millimetro

Daniel Rybakken



Millimetro

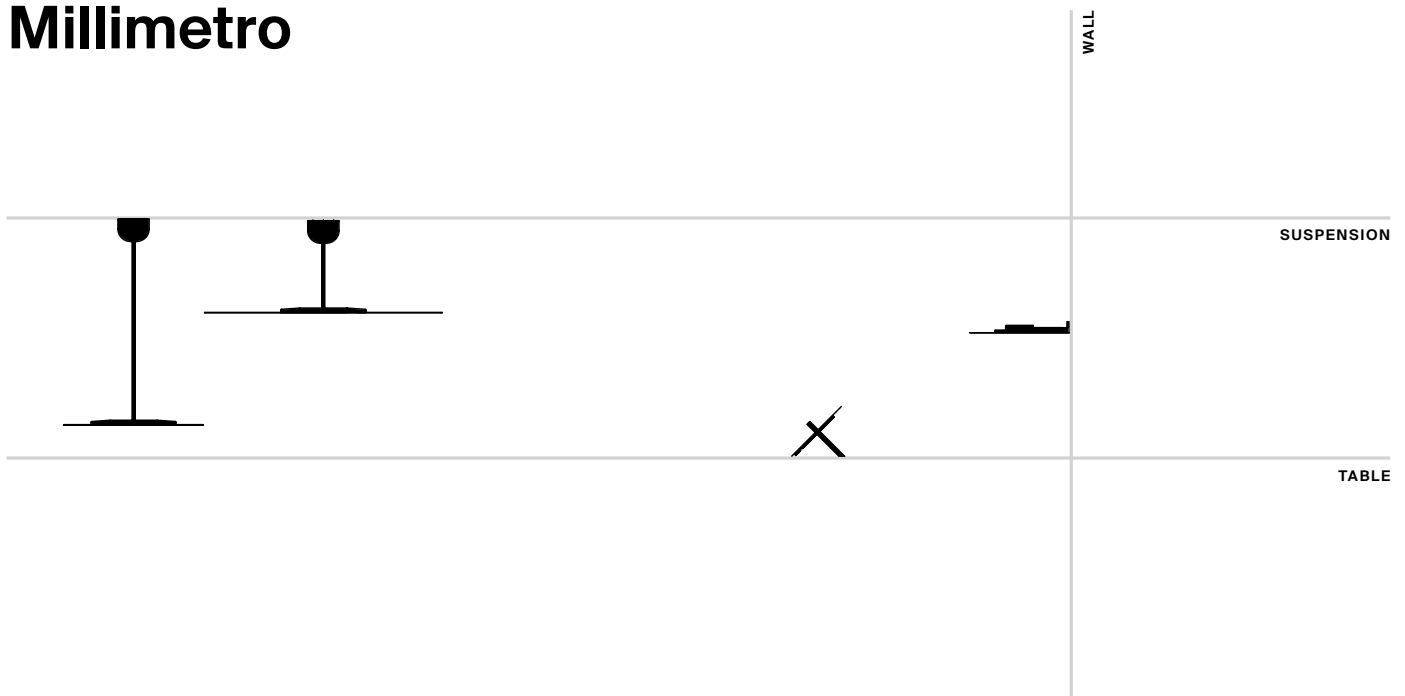

Daniel Rybakken, 2022

EN Halfway between a suspension lamp and a ceiling lamp, Millimetro brings together a very thin circular mirror-finish disk, a support structure and enveloping, warm light that spreads on the ceiling. Millimetro is at its best in elegant, prestigious contexts, thanks to its refined reflecting surface, triggering a different perspective on the surrounding space. The wall version, tangential to the surface, seems to float in space, becoming part of the wall itself. Reprising the finishes of the suspension version, it can come with an optional accessory: a thin wall plate with a circular form.

IT A metà strada tra una lampada a sospensione e una a soffitto, Millimetro è caratterizzata da un sottilissimo disco circolare a specchio, una struttura portante e da una luce avvolgente e calda che si irradia sul soffitto. Millimetro trova la sua massima espressione in contesti eleganti e prestigiosi e, grazie alla sua raffinata superficie riflettente, offre una prospettiva differente sullo spazio circostante. La versione a parete, installata tangente al muro, sembra fluttuare nello spazio, diventando parte della parete stessa. Richiamando le finiture della versione sospensione, può presentare un accessorio opzionale: una sottile piastra a parete dalla forma circolare.

DE Zwischen einer Pendelleuchte und einer Deckenleuchte angesiedelt, zeichnet sich Millimetro durch eine äußerst dünne, kreisförmige Spiegelscheibe, eine tragende Struktur und ein warmes, umhüllendes Licht aus, das an die Decke strahlt. Millimetro kommt am besten in eleganten und prestigeträchtigen Umgebungen zur Geltung. Dank der raffinierten reflektierenden Oberfläche entsteht eine besondere Perspektive auf den umgebenden Raum. Die parallel installierte Wandversion scheint im Raum zu schweben und Teil der Wand selbst zu werden. Sie erinnert in ihrer Gestaltung an die Hängeversion und kann mit optionalem Zubehör ausgestattet werden: einer schmalen, runden Wandplatte.

FR À mi-chemin entre une lampe suspendue et un plafonnier, Millimetro se caractérise par un disque circulaire très fin en miroir, une structure de support et une lumière enveloppante et chaleureuse qui rayonne sur le plafond. Millimetro trouve sa meilleure expression dans des cadres élégants et prestigieux et, grâce à sa surface réfléchissante raffinée, offre une perspective différente sur l'espace environnant. La version murale, installée tangentiellement au mur, semble flotter dans l'espace, devenant une partie du mur lui-même. Rappelant les finitions de la version suspendue, elle peut présenter un accessoire optionnel : une plaque murale mince et circulaire.

ES A medio camino entre una lámpara colgante y una lámpara de techo, Millimetro se caracteriza por un disco circular de espejo muy fino, una estructura de soporte y una luz envolvente y cálida que irradia hacia el techo. Millimetro encuentra su mejor expresión en ambientes elegantes y prestigiosos y, gracias a su refinada superficie reflectante, ofrece una perspectiva diferente del espacio circundante. La versión de pared, instalada de manera tangente, parece flotar en el espacio, convirtiéndose en parte de la propia pared. Recordando los acabados de la versión suspendida, puede incorporar un accesorio opcional: una fina placa de pared circular.





MOD. Millimetro





MOD. Millimetro

A11S50W+A11/1T-A11/1D
+ A11/2-A11/3-A11/4-A11/5
 dimmable phase cut or push/DALI
 weight 3,5 Kg
 Product use: indoor

A11S50W
+A11/1T-A11/1D
+A11/2

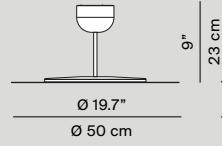

A11S85W
+A11/1T-A11/1D
+A11/2

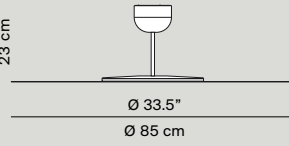

A11S50W
+A11/1T-A11/1D
+A11/3

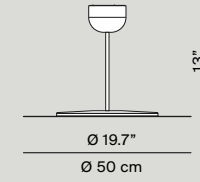

A11S85W
+A11/1T-A11/1D
+A11/3

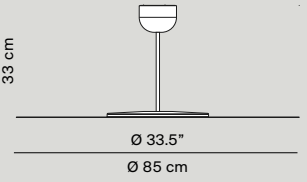

A11S85W+A11/1T-A11/1D
+A11/2-A11/3-A11/4-A11/5
 dimmable phase cut or push/DALI
 weight 6,3 Kg
 Product use: indoor

A11S50W
+A11/1T-A11/1D
+A11/4

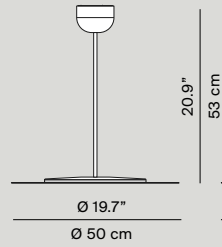

A11S85W
+A11/1T-A11/1D
+A11/4

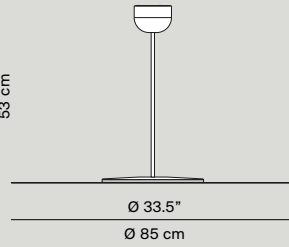

A11S50W
+A11/1T-A11/1D
+A11/5

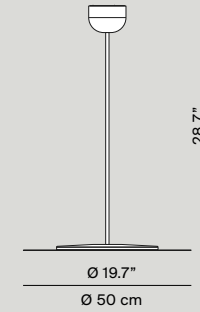

A11S85W
+A11/1T-A11/1D
+A11/5

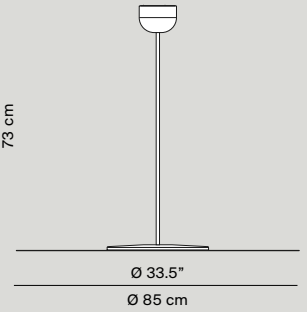

A11=1W
 dimmer on board
 weight 0,52 Kg
 Product use: indoor

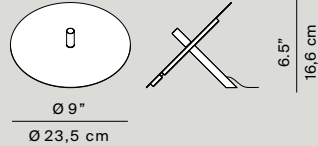



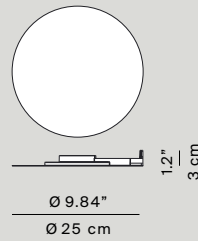



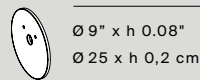



A11A25W/A11A25
 weight 0,3 Kg
 Product use: indoor



Accessory A11/6
 for A11A25 / A11A25W ONLY
 weight 0,1 Kg



Light source	A11S50W / A11S85W+A11/2-A11/3-A11/4-A11/5+A11/1D	LED 39W	2700K	CRI 90	3.393 lm	
	A11S50W / A11S85W+A11/2-A11/3-A11/4-A11/5+A11/1T	LED 37W	2700K	CRI 90	3.393 lm	
	A11A25W / A11A25	LED 22W	2700K/3000K	CRI 90	1.427 lm	
	A11=1W	LED 13W	2700 K	CRI 90	1.455 lm	
Rating system	220-240 V ~ 50/60 Hz					
Materials	Aluminium disc, steel and brass structure, technopolymer diffuser					
Structure finishes ceiling / table	 Brass mirror	 Royal blue mirror	 Aluminium mirror			
Structure finishes wall	 Aluminium mirror					
Structure finishes Accessory back plate	 Brass	 Royal blue	 Aluminium			
	  					
Reference code suspension	A11/2	1A110/020009 1A110/020020 1A110/020030				
	A11/3	1A110/030009 1A110/030020 1A110/030030				
	A11/4	1A110/040009 1A110/040020 1A110/040030				
	A11/5	1A110/050009 1A110/050020 1A110/050030				
	A11/1D	1A110/01D009 1A110/01D020 1A110/01D030				
	A11/1T *	1A110/01T009 1A110/01T020 1A110/01T030				
	A11S50W	1A110S50W018				
	A11S85W	1A110S85W018				
	Reference code wall	A11A25W	1A110A25W002			
		A11A25	1A110A250002			
		A11/6	1A110/060002 1A110/060009 1A110/060020 1A110/060030			

TECHNICAL DATA

MOD. Millimetro

*Compatible Trailing Edge Dimmer list

Manufacturer	Model	Q'ty of parallel connection
ABB	6519 U	12
ABB	6526 U	11
JUNG	224 LED UDE	12
Berker	2861	12
JUNG	254 UDIE	113
JUNG	225 TDE	12
EGANT	U321V2	12
Schneider	SBD200LED	13
Schneider	SBD315RC	12
Merten	SBD200LED	13
Berker	2874	12
Eltako	EUD61NPL-230V	10
Eltako	EUD12NPN-UC	10
Eltako	EUD12D-UC	10
Eltako	EUD61NP-230V	10
Eltako	DTD55-230V-wg	10
Eltako	DTD55L-230V-wg	10
GIRA	Universal-LED-Dimmer Mini2440 00	10
EHMANN	LED-Dimmer T46.08	9
JUNG	DrehDimmer Unlversal LED1731DD	10

TECHNICAL DATA

MOD. Millimetro

Luceplan.com