

# MESH

design Francisco Gomez Paz

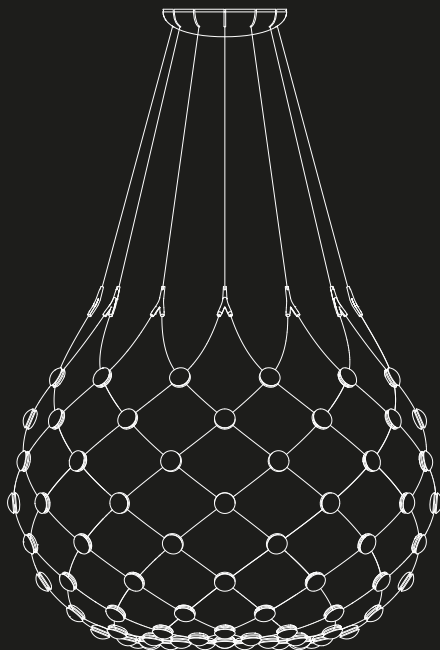

**LUCE  
PLAN**

D86KW..081A...082A...083A...084A...085A  
D86KW..101A...102A...103A...104A...105A



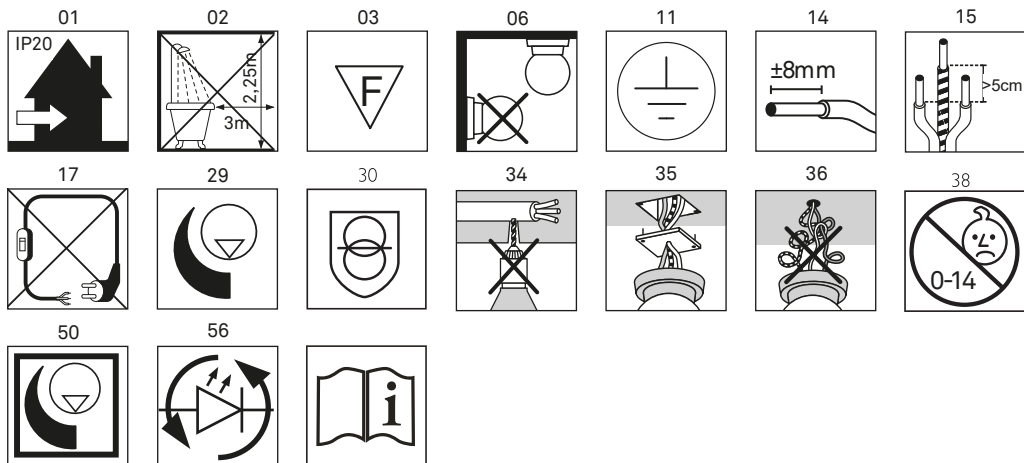

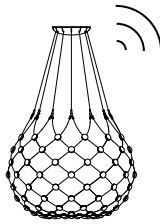

Luceplan Mesh

NEW 2021 !!



Google Play  
App Store

App minimum requirement



SSID

\*\*\*\*\*



PSK

\*\*\*\*\*



. , “ ° / £

APP



: [www.luceplan.com/products/mesh-wireless](http://www.luceplan.com/products/mesh-wireless)

MESH MASTER \*\*\*\*\*



luceplan

# D86

---

D86KW101A  
D86KW102A  
D86KW103A  
D86KW104A  
D86KW105A

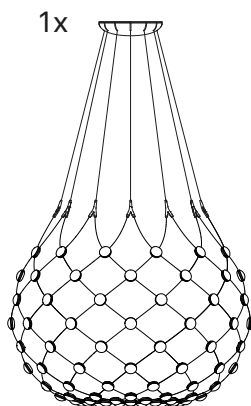

---

D86KW081A  
D86KW082A  
D86KW083A  
D86KW084A  
D86KW085A

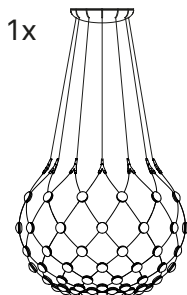

- D86KW101A
- D86KW102A
- D86KW103A
- D86KW104A
- D86KW105A

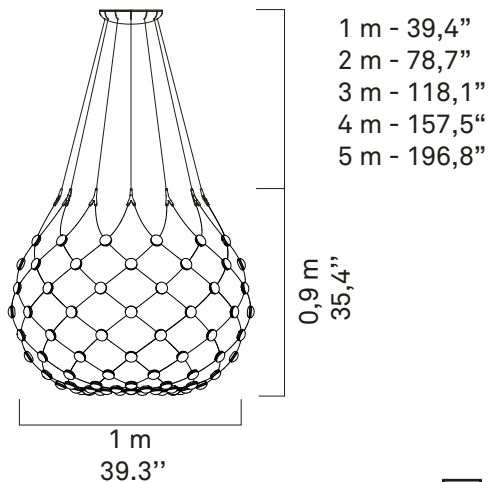

**kg** 7kg    **lb** 15,4lb

- D86KW081A
- D86KW082A
- D86KW083A
- D86KW084A
- D86KW085A

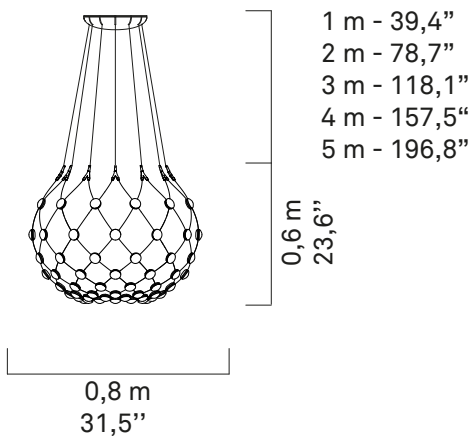

**kg** 5,6kg    **lb** 12,3lb

1

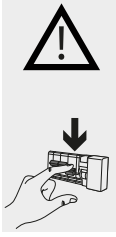

A

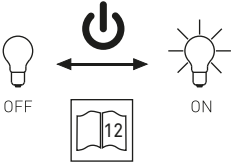
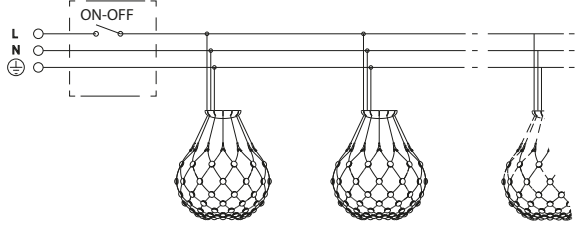
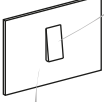

+



APP  
[www.luceplan.com/products/mesh-wireless](http://www.luceplan.com/products/mesh-wireless)

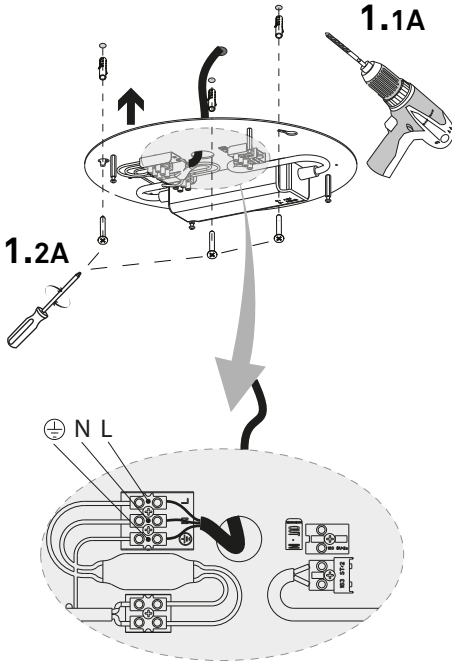

1

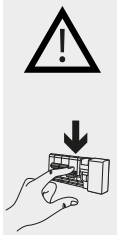

B

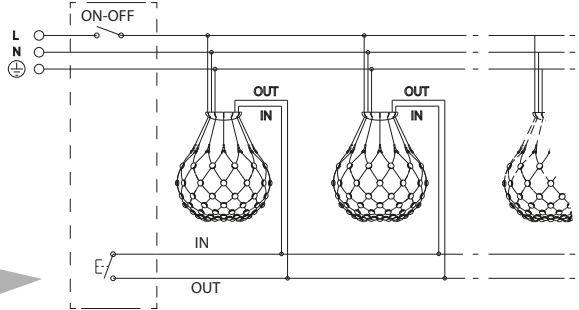
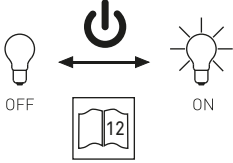
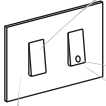

APP  
www.luceplan.com/products/mesh-wireless

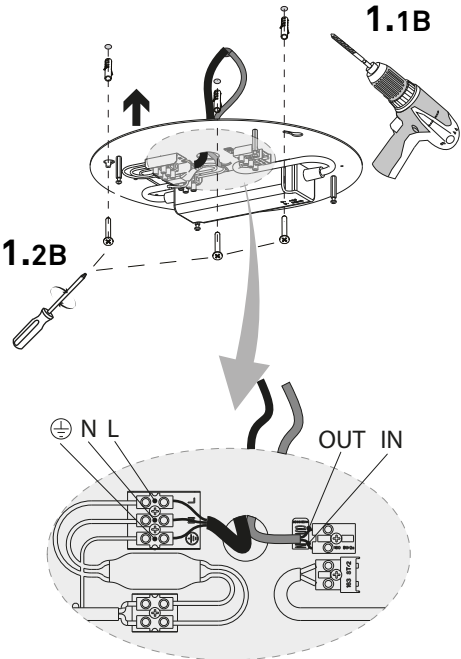

2

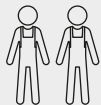

Click!

2.1

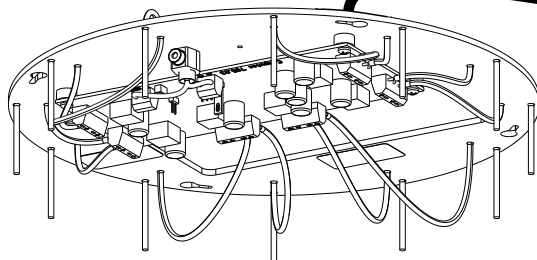
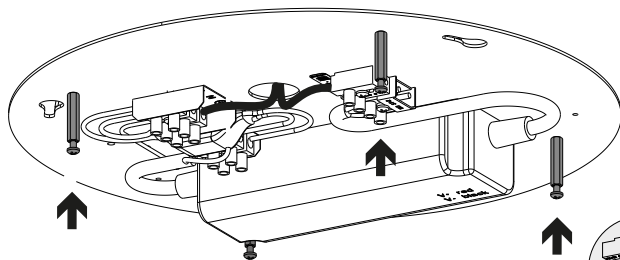
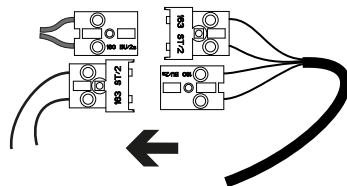

2.2

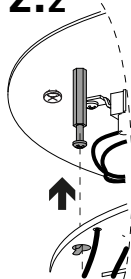

2.3

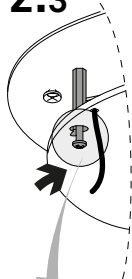

2.4

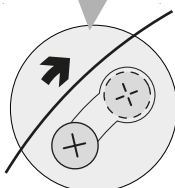
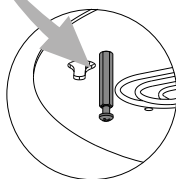
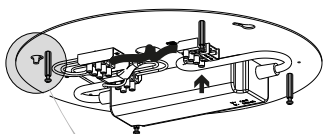
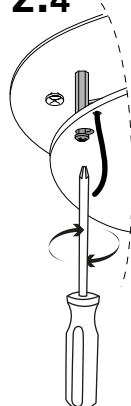



# 3

  
L. = MAX 30 cm  
(11.8")

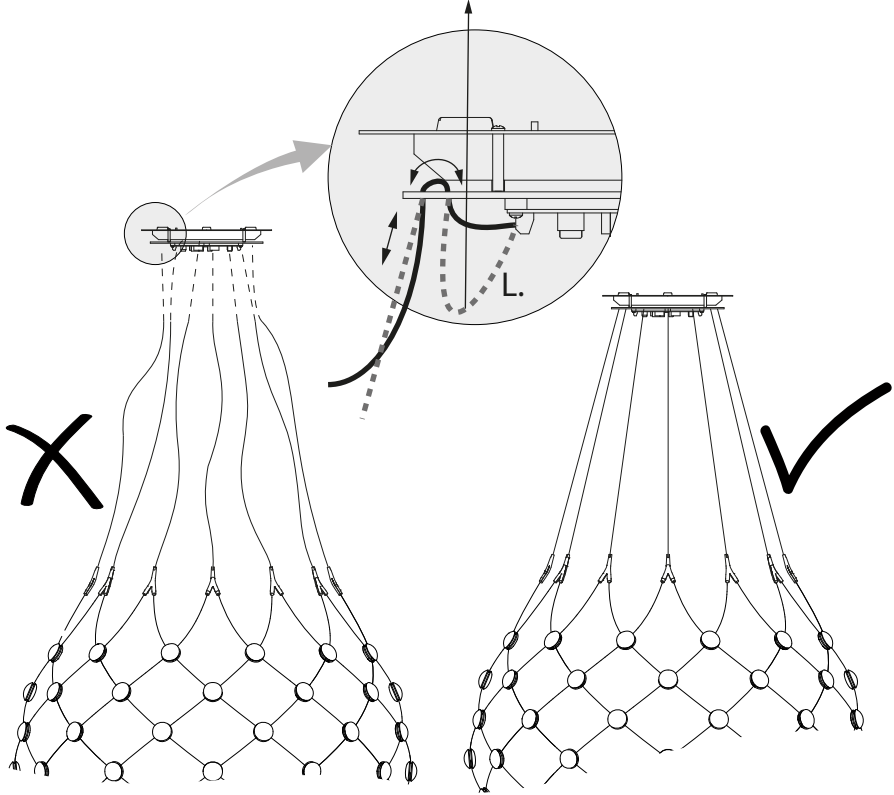

# 4

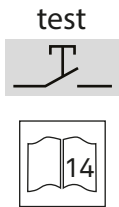
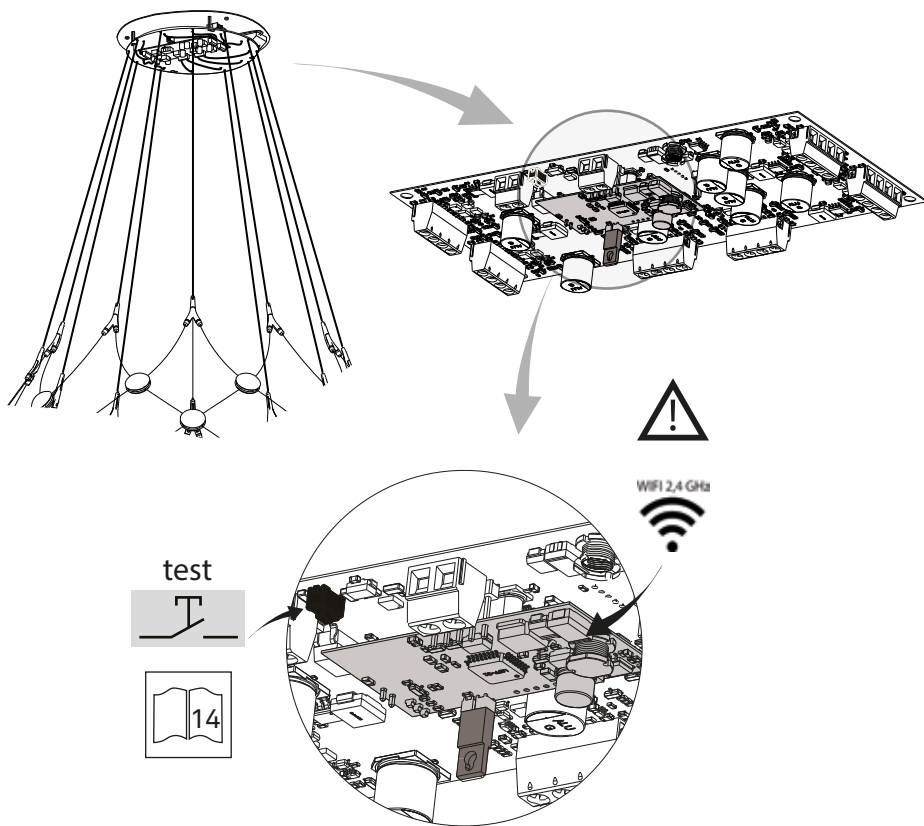

APP  
[www.luceplan.com/products/mesh-wireless](http://www.luceplan.com/products/mesh-wireless)

5

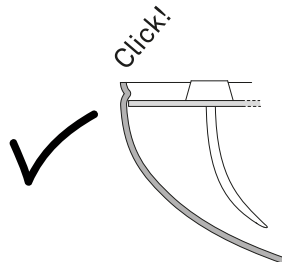
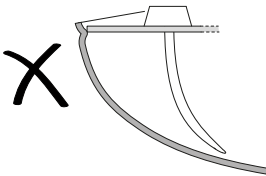
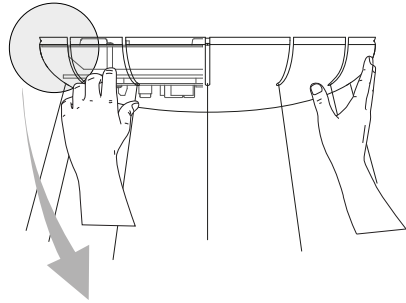
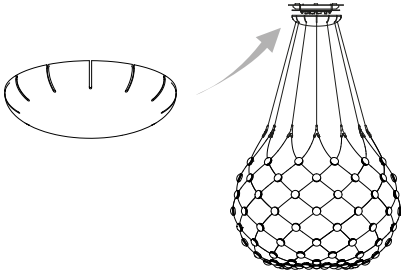
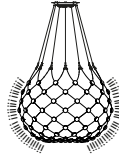
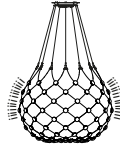
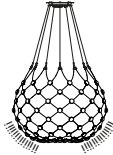
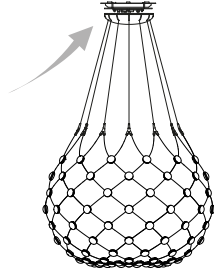
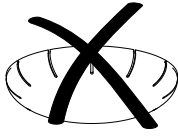

# 6

D86KW081A...082A...083A...084A...085A  
D86KW101A...102A...103A...104A...105A

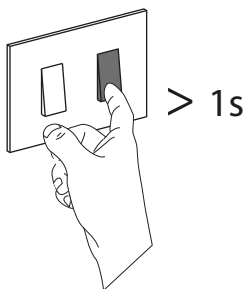
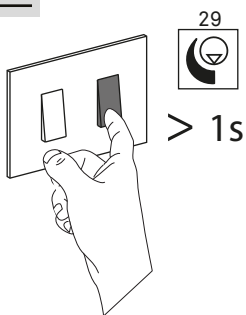
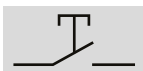
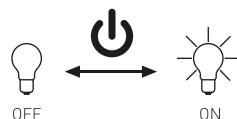
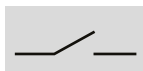

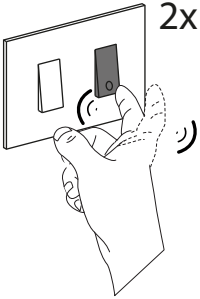
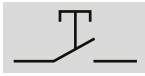

$2x < 1s$

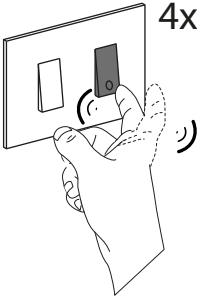
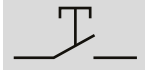
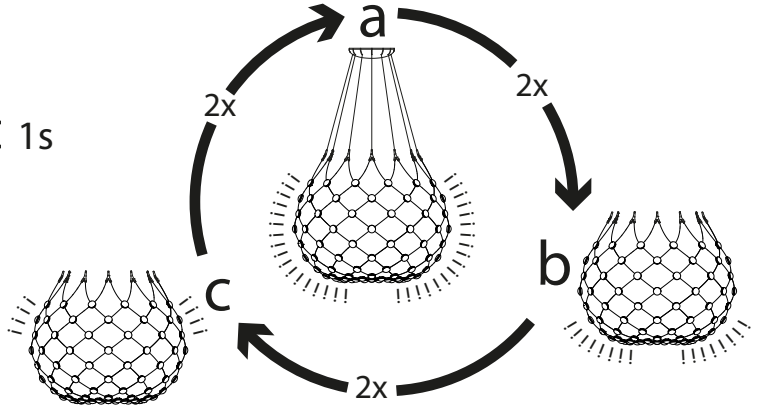

$4x < 1s \rightarrow$



$\rightarrow 4x < 1s$

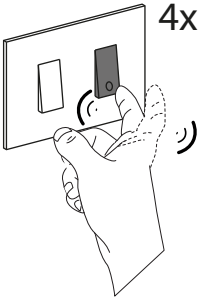
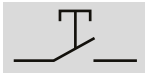
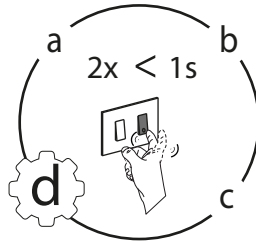

$4x < 1s \rightarrow$

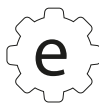

$\rightarrow 4x < 1s$

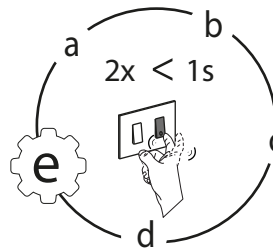

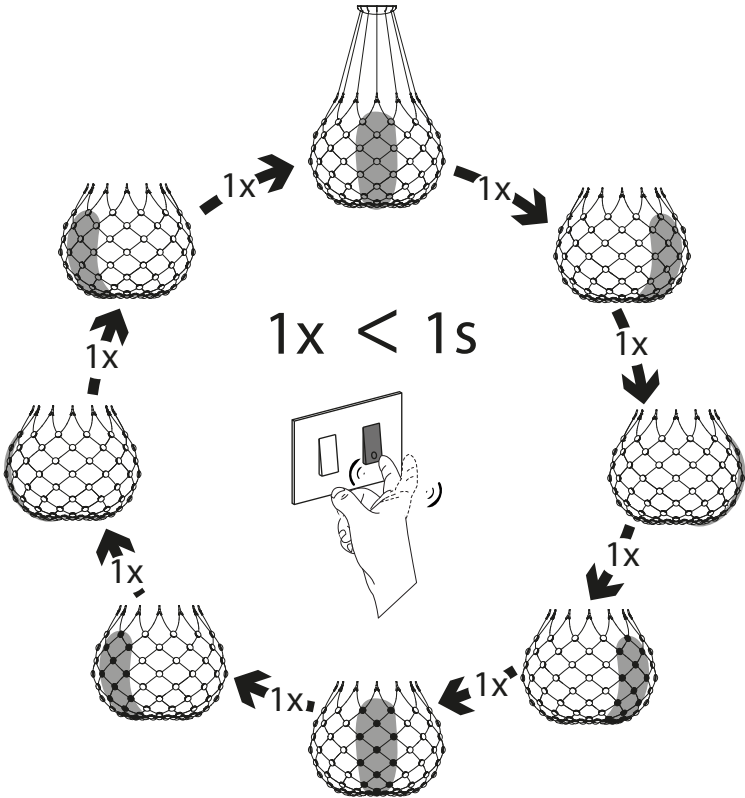
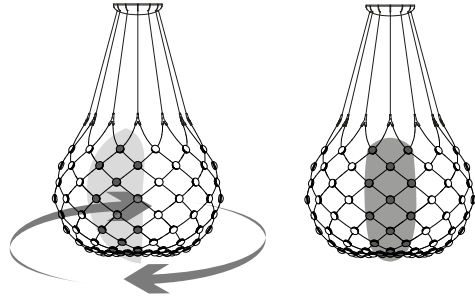
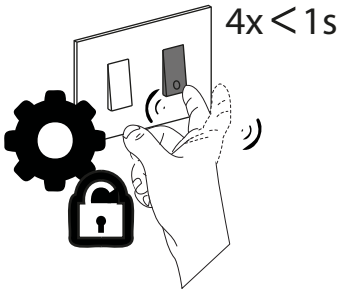

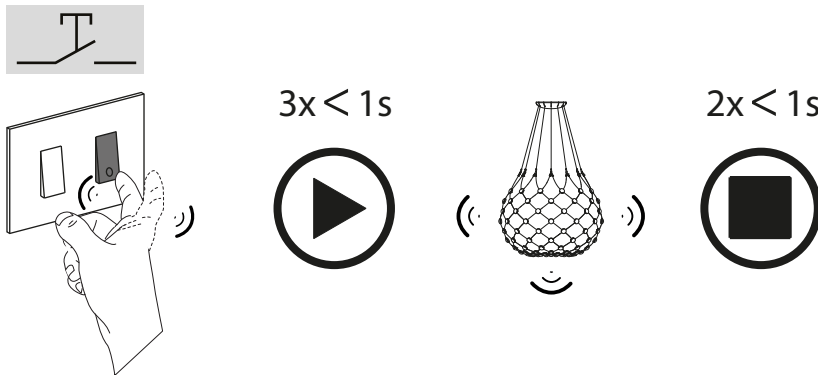
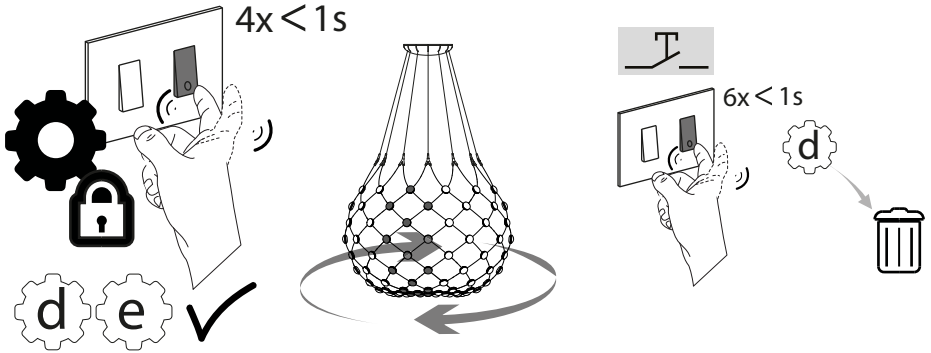
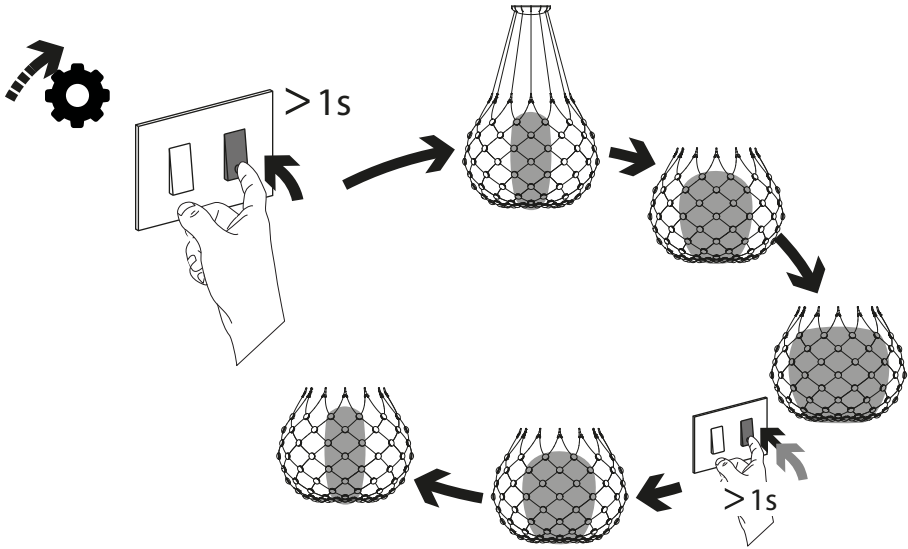

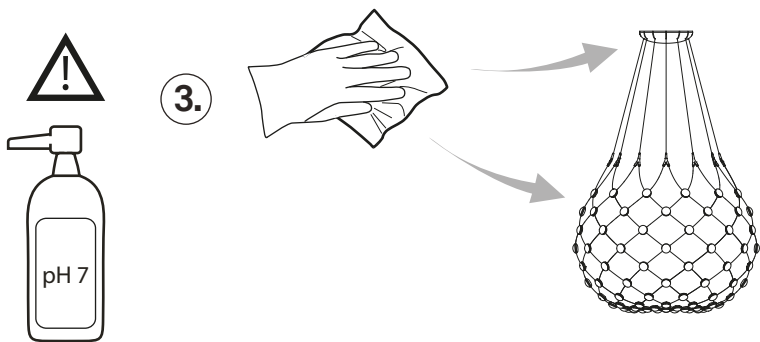
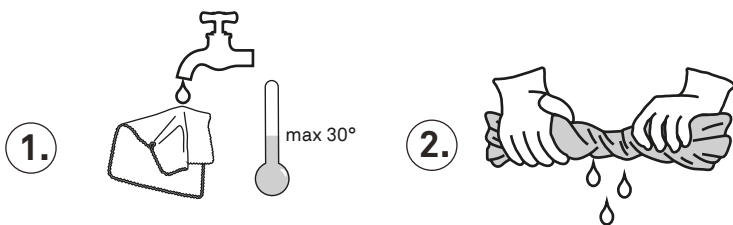
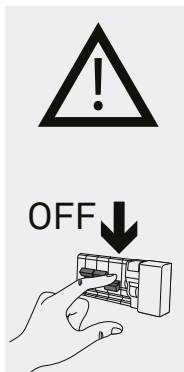











[www.luceplan.com](http://www.luceplan.com)

D860I0012