

# LITA

design David Dolcini

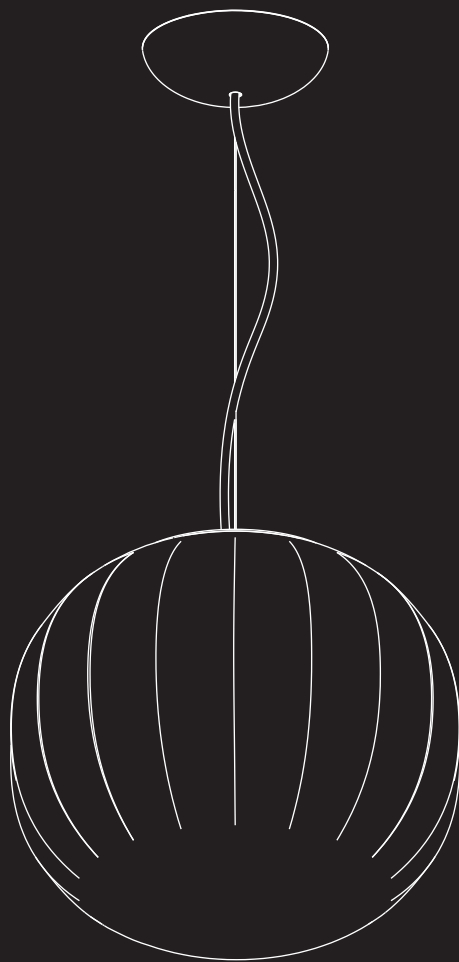

**LUCE  
PLAN**

D92



## D92S14

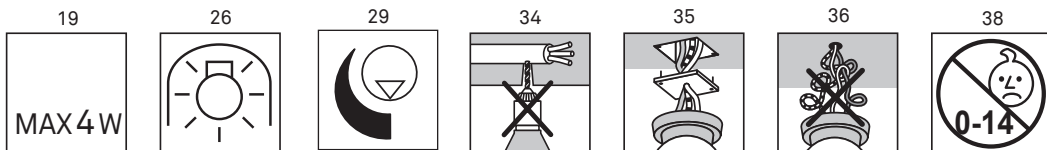
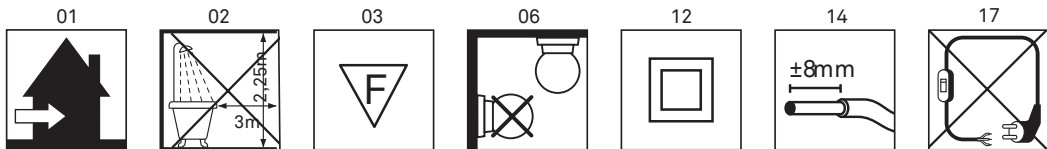

## D92S18

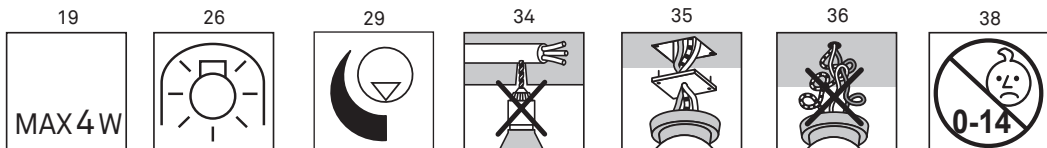
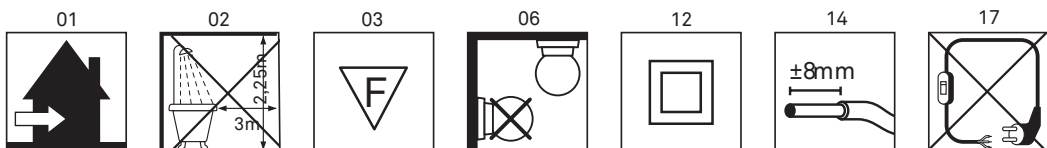

# D92S30

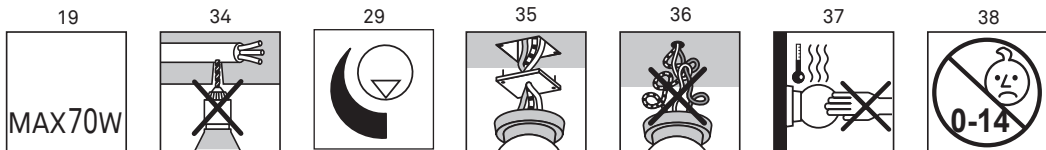
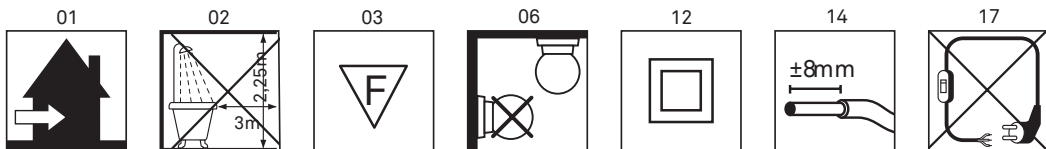

# D92S42

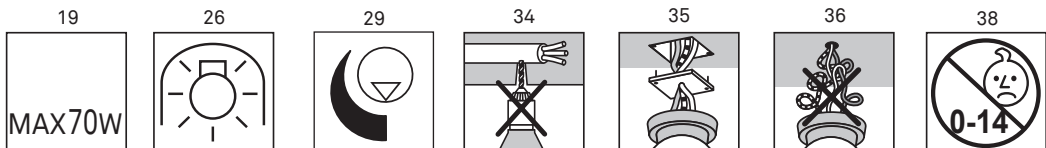
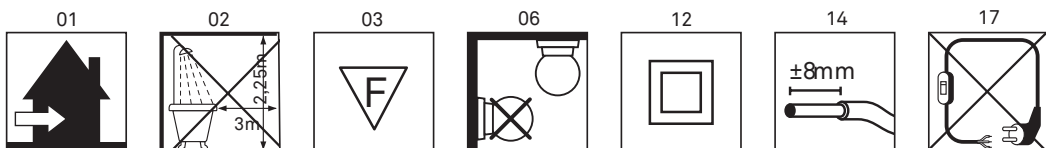

# D92S14

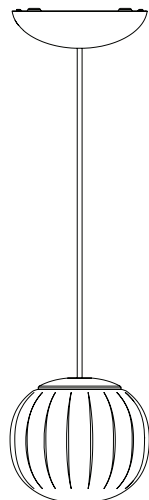

14 cm  
5.51"

max 314 cm - min. 114 cm

max 123.62" - min. 44.88"



a



b

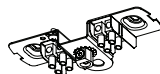

x1

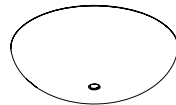

x1



x1

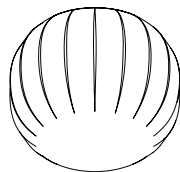

x1

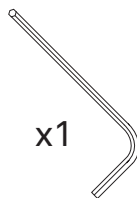

x1

kg 1.1kg

lb 2.42lb



MAX  
4W  
LED  
G9

# D92S18 + D92/2



a



b

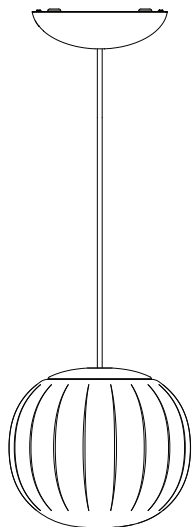

18 cm  
7.08"

max 318 cm - min. 118 cm

max 125.19" - min. 46.45"



x1

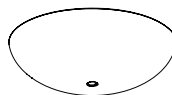

x1



x1



x1

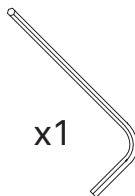

x1

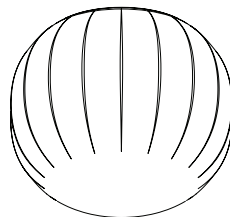

x1

kg 1.3kg

lb 2.86 lb

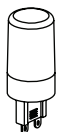

MAX  
4W  
LED  
G9

# D92S30 + D92/3

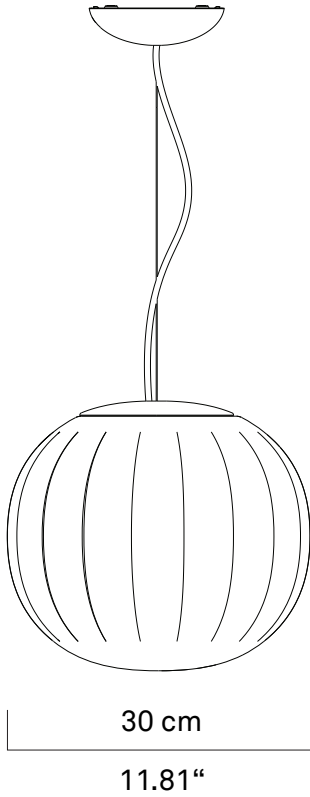

max 330 cm - min. 130 cm  
max 129.92" - min. 51.18"

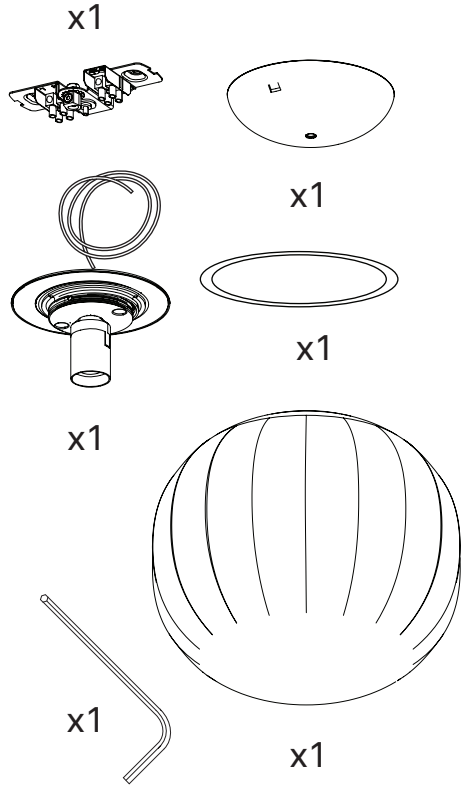
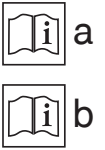

**kg** 2.3kg

**lb** 5 lb



# D92S42 + D92/4

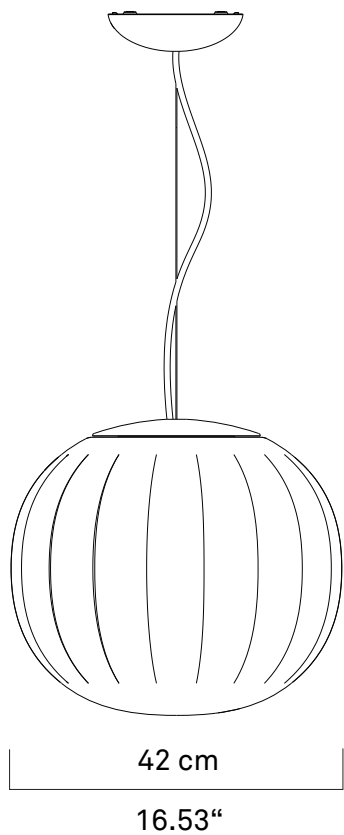

max 342 cm - min. 142 cm

max 134.64" - min. 55.90"

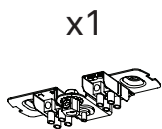

x1

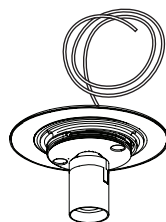

x1

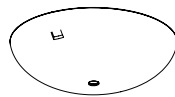

x1



x1

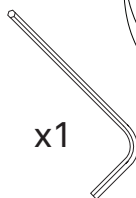

x1

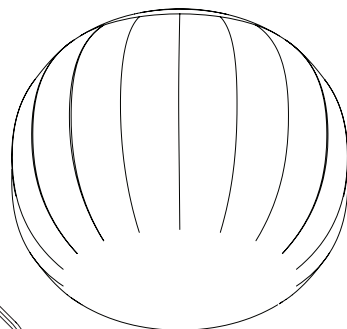

x1



a



b

**kg** 5.3kg

**lb** 11.7 lb



MAX  
16W  
LED  
E27



MAX  
70W  
E27

# 1 | 1.1 D92S14 - D92S18

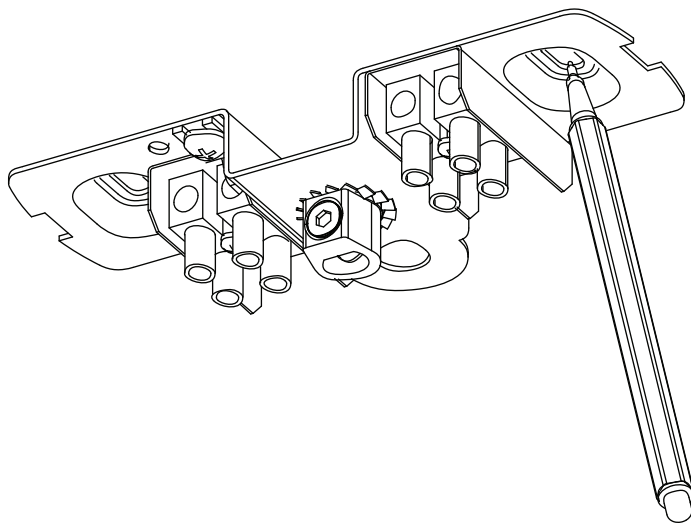

## D92S30 - D92S42

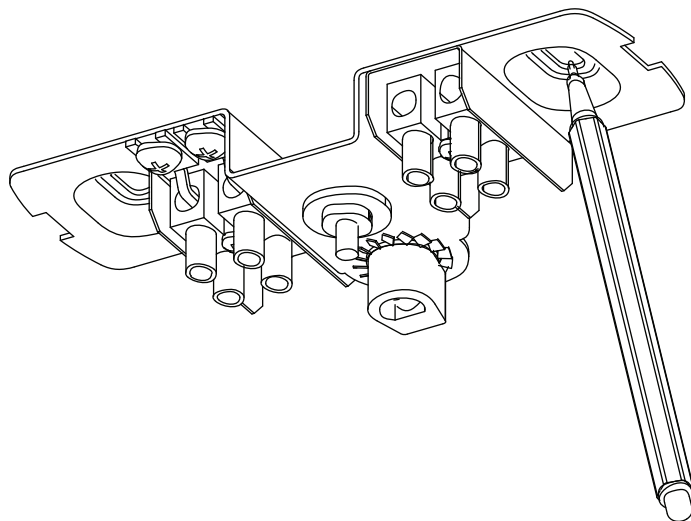



# 1.2

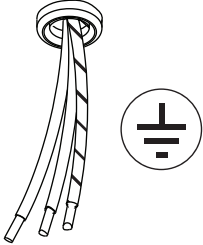
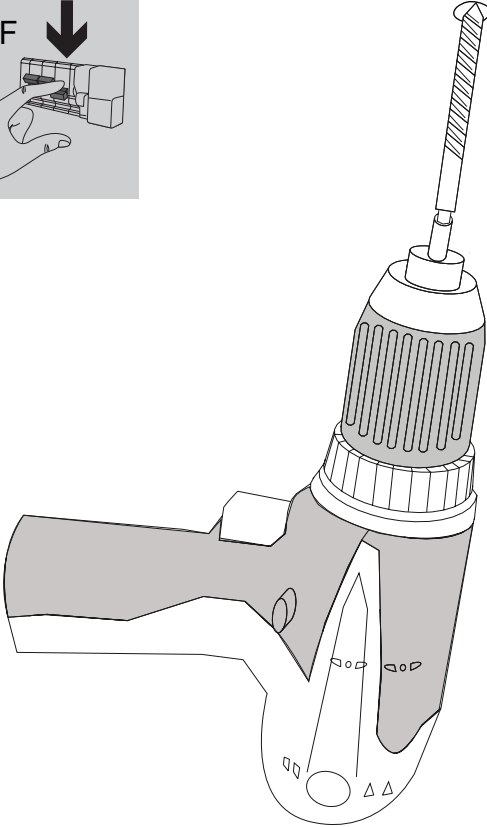
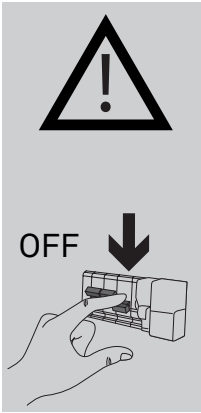

# 1.3 D92S14 - D92S18

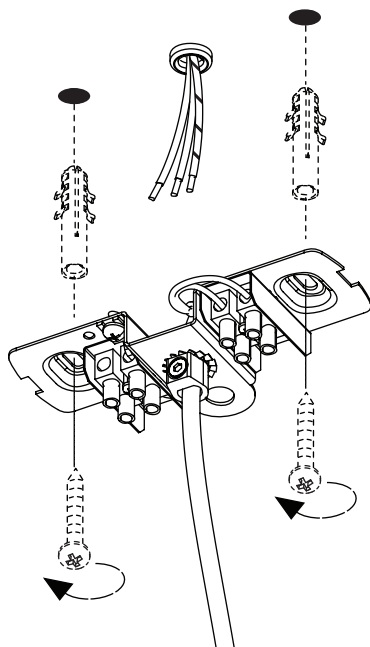

# D92S30 - D92S42

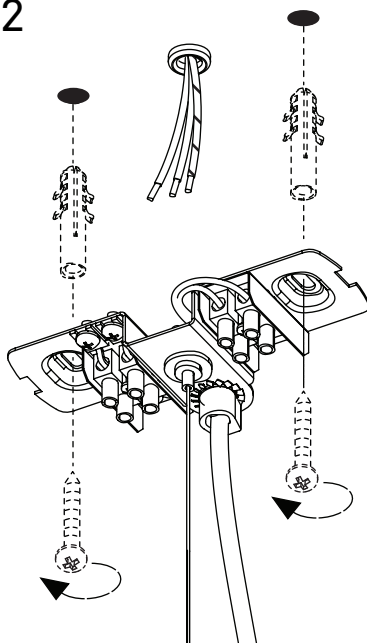

# 1.4 D92S14 - D92S18

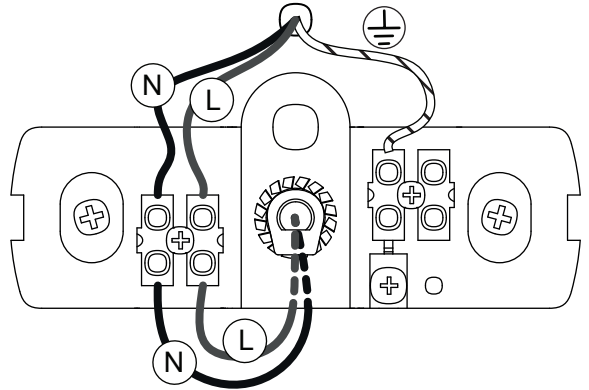
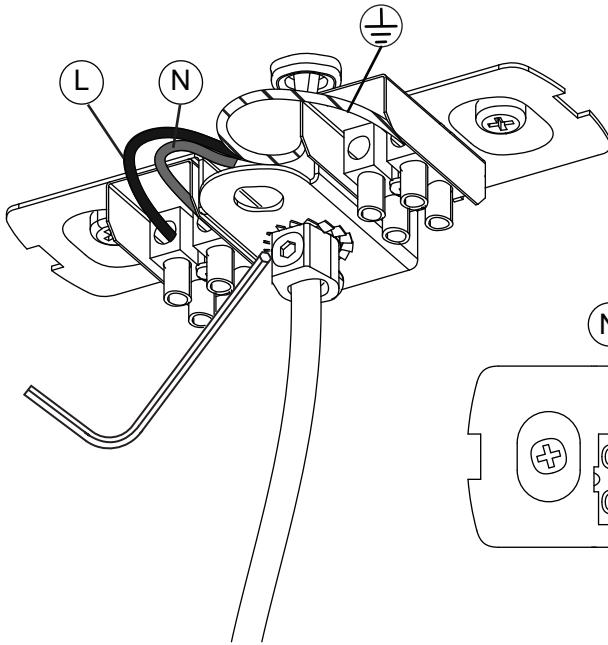

# D92S30 - D92S42

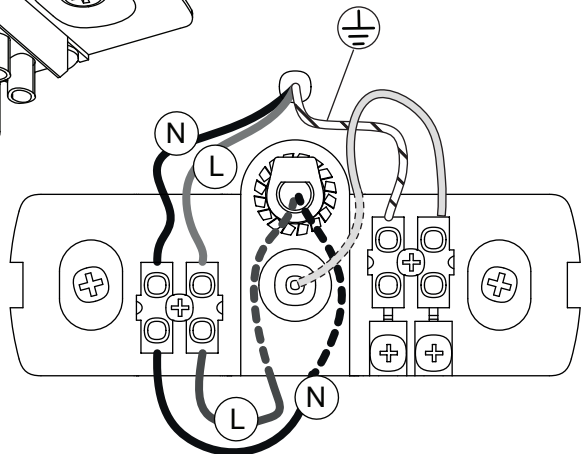
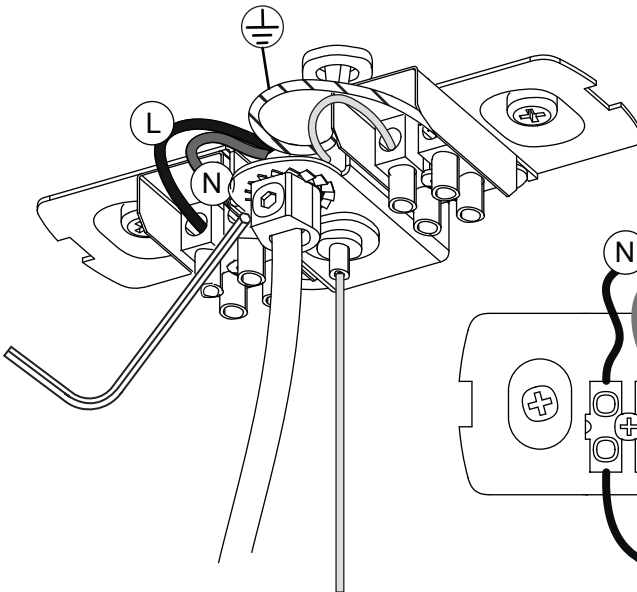

# 1.5 D92S14 - D92S18

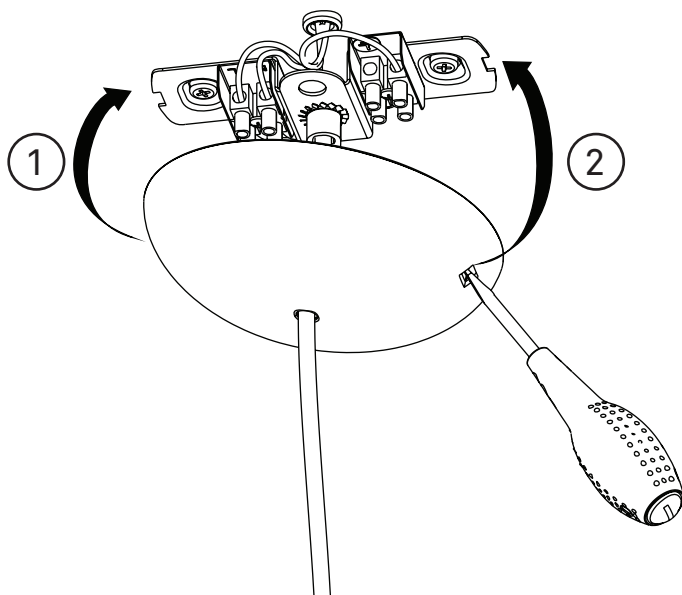

# D92S30 - D92S42

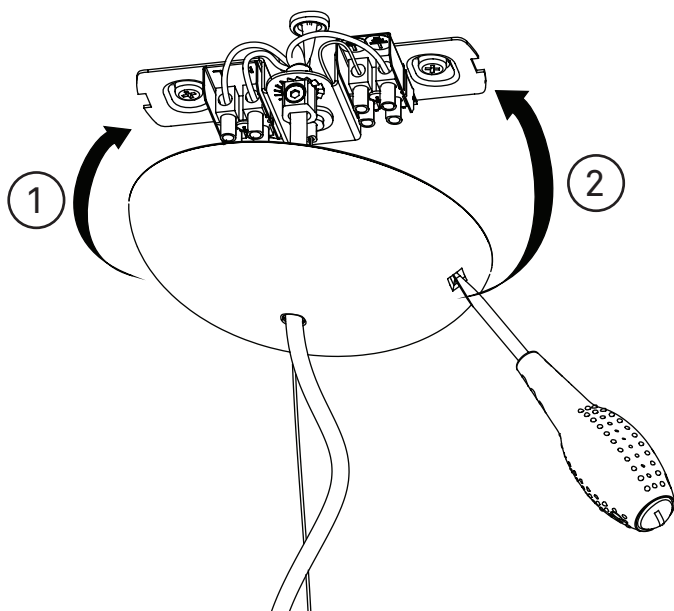

2

D92S14

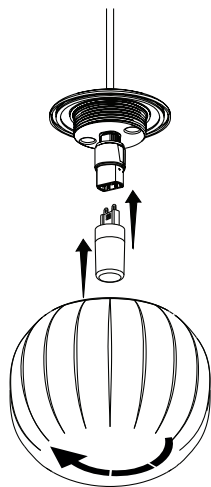

D92S18

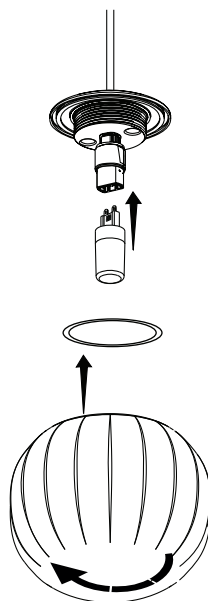

D92S30 - D92S42

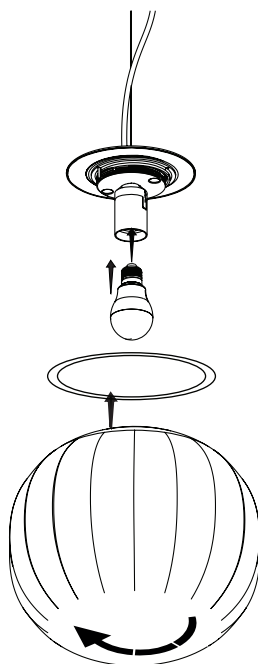

# 3

## 3.1 D92S30 - D92S42

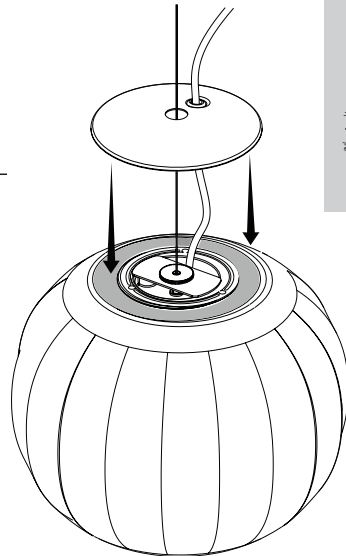
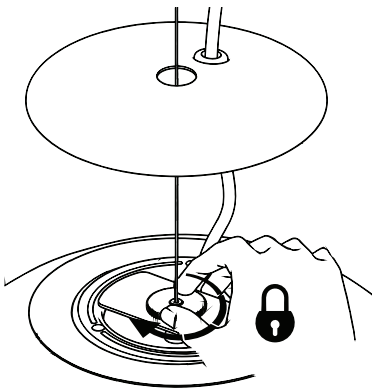
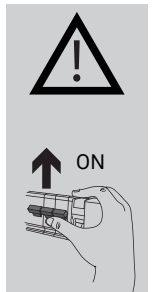
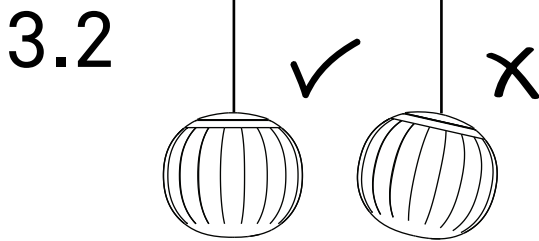
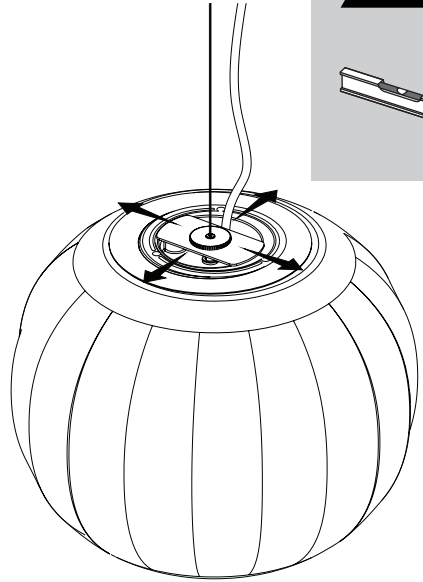
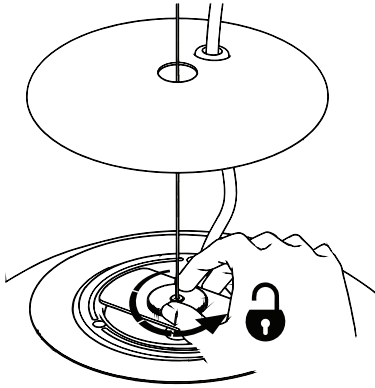
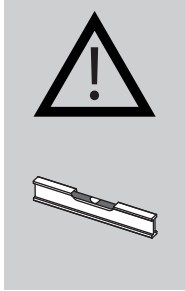

# 4

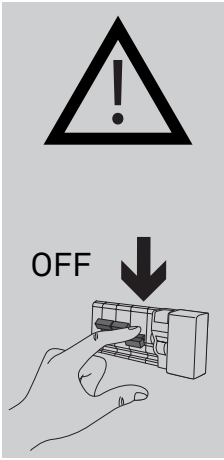

1.

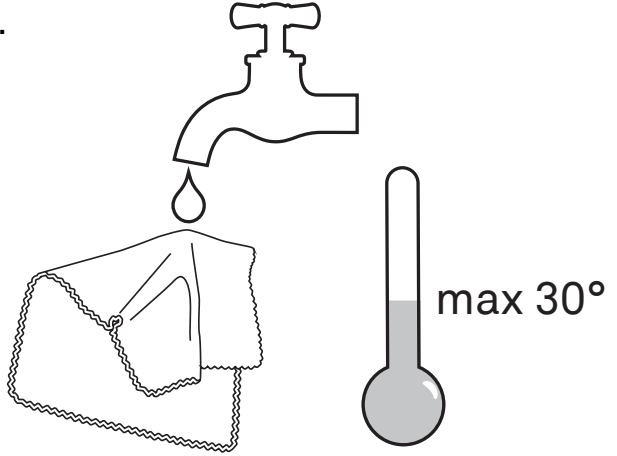

2.



3.

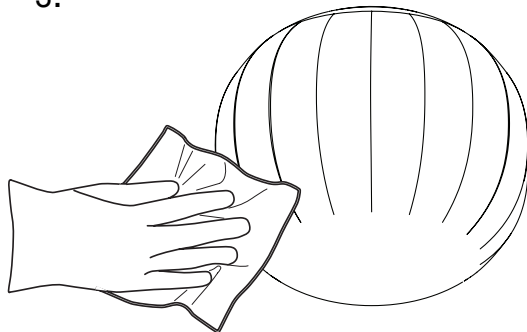



[www.luceplan.com](http://www.luceplan.com)

D9201A003